

CONTEMPORARY COLLECTION



SWAN

CONTEMPORARY
COLLECTION

SWAN



A SOURCE OF DESIRES
“sof landscapes, precious surfaces, tactile moments”

CONTENTS

6	<i>Miami Collection</i>	62	<i>Kong Collection</i>
12	<i>Host Collection</i>	74	<i>Shan Collection</i>
30	<i>Match Collection</i>	82	<i>Harvard&Norman Collection</i>
34	<i>Jazz Collection</i>	86	<i>Zip Extended version</i>
48	<i>Hills Collection</i>	94	<i>Flora Collection</i>
58	<i>Lerici Collection</i>	98	<i>Ciprea Collection</i>
		100	<i>Technical Information</i>

— 1. —
MIAMI
Collection



Miami is a chair without frontiers. Its fabric is padded for seating and structured for containing.





GEOMETRIC CADENCE
OF THE STRUCTURE
AND ATTRACTIVE
GRAPHIC DESIGN
GIVE THE CHAIR
A SPECTACULAR LOOK



— 2. —
HOST
Collection



The innovative feature is intrinsic in the formal construction. A linear and rigid outer frame contains and contrasts with soft cushions to produce a volume of great harmony.







Host Poltrona, Armchair
Hilly Tavolino, Small table

Host Divano, Sofa
Match Tavolino, Small table



A MODULAR SOFA
WITH GREAT PERSONALITY
AND VARIOUS ELEMENTS
TO ENHANCE
THE INTERIOR DESIGN
OF THE LIVING SPACE.



*Host Divano, Sofa
Match Fianco bracciolo,
Armrest side element*





da scontornare

WHEN COMFORT
IS EXPRESSED IN AN
EXCLUSIVE FORM,
THE RESULT IS A
DYNAMIC SYSTEM
OF GREAT CLASS

*Host Divano, Sofa
Match Retro divano,
Bookcase element for sofa back*





Host Extra Deep Divano, Sofa





3.

MATCH

Collection



Elegant side tables, in square or rectangular versions, and other elements comprising a bookcase, may be positioned in various manners around the sofa to perform a number of functions.





HIGHLY INNOVATIVE AND
VERSATILE ELEMENTS,
SPECIFICALLY DESIGNED
FOR COORDINATION WITH
SOFA COLLECTIONS



da scontornare

*Match Tavolini, Small tables
Match Retro divano,
Bookcase element for sofa back*

— 4. —
JAZZ
Collection



Jazz speaks the language of fashion and design, thanks to the three-dimensional texture that attires its volume.



A REINTERPRETATION OF
THE CLASSICAL FABRIC,
A DYNAMIC AND
CONTEMPORARY
PRODUCT.



Jazz Divano, Sofa
Jazz Poltroncina, Small armchair













Jazz Poltrona, Armchair
Match Tavolino, Small table

— 5. —
HILLS
Extended Version



Hills was created to enrich soft, abundant sofas with a plastic sculptural quality to render them even more generous and welcoming.







LARGE STRUCTURE,
HIGH LEVEL OF COMFORT:
SOFA IS EVEN MORE
WELCOMING

Hills Divano, Sofa
Hilly Tavolino, Small table





Hills Divano, Sofa
Ciao Tavolino, Small table
Molvido Tavolino, Small table

6.

LERICI

Collection



Essential traits and minimal volumes interpret with elegance Lerici, a project whose forms bespeak absolute comfort for moments of relaxation and pure conviviality.





Lerici Divano, Sofa
Hilly Tavolino, Small table



— 7. —
KONG
Collection



A collection of modular sofas for all kinds of customised configurations, complete with exclusive and very comfortable corner and end modules, such as dormeuses and peninsulas, as well as individual elements and poufs.





AN EXPRESSION
OF CONTINUOUS
RESEARCH INTO
FORMS, CREATING
HARMONIOUS LOOK.



da scontornare



Kong Divano, Sofa
Ciao Tavolino, Small table



Kong Divano, Sofa
Ciao Tavolino, Small table





Kong Divano, Sofa
Ciao Tavolino, Small table



*Kong Divano, Sofa
Ciao Tavolino, Small table*

— 8. —
SHAN
Collection



The Shan collection stands out for the structure of the sofa extending all the way to the floor and featuring clean, clearly defined lines.





A COLLECTION
ABLE TO MEET ANY
INTERIOR DESIGN NEED
AND STYLING
PREFERENCE.



Shan Divano, Sofa
Ciao Tavolino, Small table



9.

HARVARD & NORMAN Collection



Testo, testo testo testo testo Testo, testo
 testo testo testo Testo, testo testo testo
 testo Testo, testo testo testo testo Testo,
 testo testo testo testov Testo, testo testo
 testo testo



Fra comprendere e voler bene guardare, altre ascoltare; nella vita si danno casi in cui entrambi le cose si rendono necessarie. Uno è quello. Passare tra le pagine diventa più semplice, dopo aver sentito qualche parola, qualche pensiero della vita di chi alle pagine ha dato vita, diventa in qualche modo più facile. E' per questo che ho dovuto fare qualche domanda. Non spiega, racconta. O forse spiega, pur non volendo farlo.

Sarah Albani

Che cosa ti ha parlato e quello lavoro

1. ... Parlo con gli altri e lo stile per il mio lavoro

2. ... Come capita talora di la necessità, le necessità, l'idea del "non visto" che il pensiero di scrittura come in questo caso) che "senza spiegare" intendiamo per "facile" e scrivere con "facile per il nostro lavoro per poter ottenere l'attenzione di qualcuno in discussione.

Che cosa ti ha parlato di più di quanto lo Gullone/Pablo?

1. ... In primo dei suoi scritti, documentaristi messi che sembrano affettuosi, politici in movimento, mai definiti, sono raccontati e definiti, non sono il commesso di tutto in vita per una squadra emozionalmente scritta.

2. ... Sono che le installazioni di fatto, parte di questo specifico lavoro, sono il legame perfetto tra realtà "spiega" e natura "fatta". Sono ancora, precisione e questo senza leggere qualcosa o scrivere, in contemporanea, alla scrittura.

Che cosa non riuscivi mai a parlare di?

1. ... In questa vita materiale sono di fatto essere partecipativo, mentre molto legato a tutto ciò che vi ha creato emozioni per essere il segno di presenza di una bellezza lontana in un particolare momento, un senso come quello di un personaggio meraviglioso di cui indagare tutto che non ha presenza ed una persona cara

2. ... Il cambiamento, anzitutto il ricordo del cambiamento, del viaggio

Qual è stato la cosa più difficile? E quella che ti è piaciuta di più?

1. ... Il fatto è stato difficile, ma non altrettanto difficile scrivere che gli aspetti da raccontare non divennero sempre più, sempre, ma "leggere un discorso", ogni volta per di qualcosa lontane e questi tratti, difficile e' stato capire che il mio lavoro non doveva essere complicato, difficile, piuttosto che fondamentalmente tecnico. Nonni avevano qualcosa di importante, andare all'ufficio di tutti i giorni erano contemporaneamente affogati in un'emozione e un'emozione della trasformazione e prendere il lavoro senza scendere in fretta, per il fatto di gioco, tutto e' stato in qualche modo modificato rispetto a come ho visto realmente, nel progetto, nel momento in cui ho iniziato a più letteralmente impegnato, invece di dialogare con elementi culturali, quali film, figure, opinioni, storie, storie, acrobazie e risultati, sono stati di commoventi emozioni, stati come quelli, or'ora è il giorno successivo nella vita di lavorare tutto possibile forme, difficile e' stato accettare che tutti le prime, la più preziosa e grande tra tutte per questo la più una, almeno come documentata, per essere raccontata non e' mai stata scritta e' stato altrettanto. Nonni materiali, ma soltanto con per che era disposta nel momento del film, senza in alcuni momenti essere coperti e contemporaneamente con uno di scrivere "nonni" e scrivere.

2. ... Non si sono state fotografie più difficili o più facile (per riferirsi a quello in qualche momento), hanno sempre, anche altre fotografie, abbandonando, e più che altro, ... avere con per la scrittura fotografica. Quali tempi e l'abilità maggiore che tutti la più tutte, le altre, erano state in far lavorare a questi in modificando, cambiando il punto di vista e aspettando una loro storia



Harvard Divano, Sofa

nella pagina precedente, on the previous page

Norman Divano, Sofa

— 10. —
ZIP
Collection



Zip is a collection made up of different elements. The name reveals the collection's hallmark: a vertical zip in brushed metal that comes in five different colors.





DETAILS OF DESIGN,
STRIKING AESTHETICS,
CONTEMPORARY
LIFESTYLES.



Zip Divano, Sofa
Hilly Tavolino, Small table



— 11. —
FLORA
Collection



A deliberately slender project, taking up little space: a small armchair that may serve as a passe-partout in the home, made-to-measure for every occasion.





*Flora Chaise Longue
Flora Poltrona, Armchair
Ciao Tavolino, Small table*



— 12. —
CIPREA
Collection



Ciprea is an expression of creativity and character that stands out with its elegant, retro-inspired style.



CIPREA

Design ludovica+roberto palomba

2 poltrone + 1 pouf
 Struttura in legno con cinghie elastiche e imbottitura in poliuretano espanso a quote differenziate rivestita in fibra accoppiata con vellutino.
 Cuscino di seduta in poliuretano espanso rivestito in maglina.
 Cuscino poggiatesta in Dacron® accoppiato.
 Poltrone con base girevole in metallo cromato o piedini in legno.
 Nell'area interna (seduta e schienale) il rivestimento – in tessuto o pelle completamente sfoderabile - è accoppiato ad una materassina imbottita in cotone e fibra resinata.

2 armchairs + 1 ottoman
 Structure in wood with elastic straps. Structure pad in expanded polyurethane, with differentiated density, upholstered in fibre coupled with fine velveteen.
 Seat cushion in expanded polyurethane fibre covering coupled with jersey.
 Lumbar cushion in Dacron® fiberfill.
 Armchairs available with swivel base in chrome-plated metal or with wooden feet. In the inner surface (seat and backrest) the upholstery is matched to a padded mat in cotton and resin fibre. Elements upholstered in completely removable fabric or completely removable leather.

2 fauteuils + 1 pouf
 Structure en bois, courroies élastiques, rembourrage en polyuréthane expansé, à niveaux différenciés, revêtu de fibre unie à de la toile compensée.
 Coussin d'assise en polyuréthane expansé, revêtu de maille fine.
 Coussin lombaire en ouate synthétique Dacron®.
 Fauteuils avec base pivotante en métal chromé ou pieds en bois.
 Dans la surface interne (assise et dossier) le revêtement est jumelé à un matelas en coton et fibre résinée.
 Revêtement en tissu ou en cuir entièrement déhoussable.

2 Sessel + 1 Hocker
 Holzstruktur mit elastischen Gurten.
 Polyurethanschäumstoff-Polsterung zu unterschiedlichen Anteilen und Faser/Samt-Bezug.
 Sitzkissen aus Polyurethanschäumstoff mit Trikotbezug.
 Lendenkissen aus Dacron® Faser. Sessel mit drehbarer Basis aus verchromtem Metall oder Holzfüße. In der Innenfläche (Sitz und Rückenlehne) ist der Bezug zu einer gepolsterten Matte aus Baumwolle und Harzfaser gepaart. Elemente mit Stoffbezug vollständig abziehbar; Elemente mit Lederbezug vollständig abziehbar.

Trattandosi di prodotti caratterizzati da imbottiture morbide e da una lavorazione artigianale, le dimensioni indicate nelle schede tecniche possono subire leggere variazioni, anche in base alle diverse opzioni di rivestimento.
 La formazione di pieghe nei cuscini di seduta non è da considerarsi un difetto, bensì una caratteristica dettata da motivi di comfort e di design.

Comme nos produits sont caractérisés par des lignes douces et sont fabriqués suivant une procédure artisanale, les dimensions indiqués dans les fiches techniques peuvent varier légèrement (même en fonction du revêtement choisi).
 Pour des raisons à la fois de confort et de design, l'apparition de plis et l'effet de miroitement sont deux phénomènes inévitables, même sur les sièges de très haut de gamme portant la griffe Swan Italia.

EL115

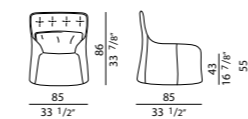

EL116

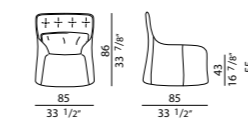

EL120

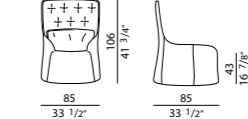

EL121

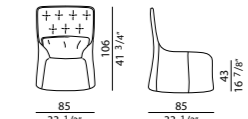

EL125

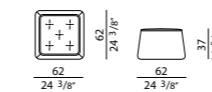

As our products are produced following a handwork procedure and are featured by soft lines, sizes are subject to slight variation (also depending on the upholstery selected).
 Wave formation and depressions in the seat area are unavoidable, due to comfort and design reasons, even in high quality Swan Italia upholstered furniture.

Wegen der handwerklichen Fertigung und der soften Linien unserer Produkte, unterliegen die Masseangaben leichten Schwankungen (auch abhängig von dem gewählten Bezug).
 Wellenbildung und Sitzspiegel sind aus Komfort- und Designgründen auch bei hochwertigen Swan Italia Polstermöbeln nicht zu vermeiden.

Our company retains the right to make technical and design modifications to the products in each moment without any advice.

Die Firma behält sich das Recht vor, technische Modelländerungen vorzunehmen.

Design ludovica+roberto palomba

2 poltrone + 1 chaise longue

Poltrone: Struttura in legno con cinghie elastiche e imbottitura in poliuretano espanso a quote differenziate rivestita in fibra accoppiata con vellutino. Cuscino di seduta in poliuretano espanso rivestito in maglina.

Cuscino poggiatesta in piuma.

Base girevole in metallo cromato o piedini in legno.

Rivestimento - in tessuto o in pelle completamente sfoderabile - costituito da due materassine imbottite: una esterna (struttura) in cotone e fibra resinata ed una interna (seduta e schienale) in Solotex®.

Tali materassine sono unite fra loro da un'unica zip che assume pertanto, contemporaneamente, un ruolo funzionale ed uno estetico.

Chaise longue: Struttura in legno con cinghie elastiche e imbottitura in poliuretano espanso a quote differenziate rivestita in fibra accoppiata con vellutino.

Cuscino di seduta in poliuretano espanso rivestito in maglina.

Cuscino poggiatesta in piuma. Piedini in legno.

Rivestimento in tessuto o in pelle completamente sfoderabile

2 fauteuils + 1 chaise longue

Fauteuil: Structure en bois, courroies élastiques, rembourrage en polyuréthane expansé, à niveaux différenciés, revêtu de fibre unie à de la toile compensé.

Coussin d'assise en polyuréthane expansé, revêtu de maille fine.

Coussin lombaire en plume.

Base pivotante en métal chromé ou pieds en bois.

Revêtement - en tissu ou en cuir complètement déhoussable - composé par 2 matelas rembourrés : un externe (structure) en coton et fibre résinée et un interne (assise et dossier) en Solotex®. Les matelas sont unis entres eux par une seule fermeture éclair qui joue en même temps un rôle fonctionnel et esthétique.

Chaise longue : Structure en bois, courroies élastiques, rembourrage en polyuréthane expansé, à niveaux différenciés, revêtu de fibre unie à de la toile compensé.

Coussin d'assise en polyuréthane expansé, revêtu de maille fine.

Coussin lombaire en plume.

Pieds en bois.

Revêtement en tissu ou cuir entièrement déhoussable.

2 armchairs + 1 chaise longue

Armchairs: structure in wood with elastic straps. Structure pad in expanded polyurethane, with differentiated density, upholstered in fibre coupled with fine velvet.

Seat cushion in expanded polyurethane fibre covering coupled with jersey. Lumbar feather cushion.

Swivel base in chrome-plated metal or wooden feet.

Upholstery - completely removable fabric or completely removable leather - made up by 2 padded mats: outer mat (structure) in cotton and resin fibre, inner mat (seat and backrest) in Solotex®. The mats are joined together thanks to a zip closure which plays at the same time a functional and aesthetic role.

Chaise longue: structure in wood with elastic straps. Structure pad in expanded polyurethane, with differentiated density, upholstered in fibre coupled with fine velvet. Seat cushion in expanded polyurethane fibre covering coupled with jersey. Lumbar feather cushion. Wooden feet. Upholstery in completely removable fabric or completely removable leather.

2 Sessel + 1 Chaise Longue

Sessel: Holzstruktur mit elastischen Gurten.

Polyurethanschaumstoff-Polsterung zu unterschiedlichen Anteilen und Faser/Samt-Bezug.

Sitzkissen aus Polyurethanschaumstoff mit Trikotbezug.

Lendenkissen aus Daunen.

Drehbare Basis aus verchromtem Metall oder Holzfüße.

Der Bezug besteht aus 2 gepolsterten Matten: die Außenmatte (Struktur) ist aus Baumwolle und Harzfaser, die Innenmatte (Sitzfläche und Rückenlehne) ist aus Solotex®. Die Matten sind durch einen Reißverschluss verbunden, der gleichzeitig eine funktionelle und ästhetische Rolle spielt.

Elemente mit Stoffbezug vollständig abziehbar; Elemente mit Lederbezug vollständig abziehbar.

Chaise Longue: Holzstruktur mit elastischen Gurten.

Polyurethanschaumstoff-Polsterung zu unterschiedlichen Anteilen und Faser/Samt-Bezug. Sitzkissen aus Polyurethanschaumstoff mit Trikotbezug. Lendenkissen aus Daunen. Holzfüße.

Elemente mit Stoffbezug vollständig abziehbar; Elemente mit Lederbezug vollständig abziehbar.

EL 100

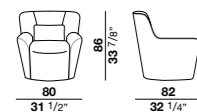

EL 101

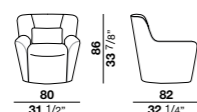

EL 105

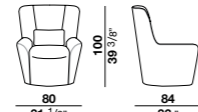

EL 106

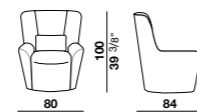

EL 110

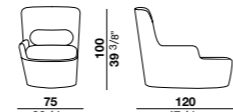

EL 01

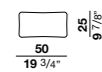

EL 02

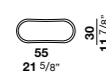

HILLS

pg. 48

Design ludovica+roberto palomba

I nuovi elementi profondi Hills fotografati nel presente catalogo completano la collezione Hills contenuta nel catalogo 09/10.
 4 divani + 41 elementi componibili + 2 divani letto + 3 divani relax + 3 pouf
 Struttura in legno con cinghie elastiche, con tamponi in poliuretano espanso, rivestita con materassina in piuma.
 Cuscini schienale in piuma rivestiti in cotone.
 Cuscini seduta in piuma con inserto in poliuretano espanso, a quote differenziate, rivestiti in cotone e cotone accoppiato.
 Piedini in metallo verniciati a polvere, con puntale antiscivolo.
 Elementi rivestiti in tessuto completamente sfoderabili; elementi rivestiti in pelle con cuscinate sfoderabile e struttura non sfoderabile.
 Cuscini di schienale predisposti per l'inserimento di un telaio che consente la regolazione del poggiatesta. Il telaio è opzionale.
 Divano letto con rete elettrosaldata e materasso ortopedico in espanso. Divano con movimento relax che permette la fuoriuscita del cuscino di seduta.

Les nouveaux éléments profonds Hills montrés dans ce catalogue complètent la collection Hills qui figure largement dans le catalogue 09/10.
 4 canapés + 41 éléments composables + 2 canapés avec lit + 3 canapés relax + 3 poufs.
 Structure en bois, courroies élastiques, tampon en polyuréthane expansé, revêtu d'un matelassé en plume.
 Coussins du dossier en plume revêtus coton.
 Coussins de l'assise en plume et polyuréthane expansé, à niveaux différenciés, revêtus coton et coton compensé.
 Pieds en métal vernis à poudre, avec système antidérapage.
 Éléments revêtus de tissu, entièrement déhoussables; éléments revêtus en cuir, coussins entièrement déhoussables, structure non déhoussable. Coussins dossiers disposés pour l'insertion d'un châssis pour le réglage de l'appuie-tête. Le châssis est en option.
 Canapés-lits avec sommier électro-soudé et matelas orthopédique en expansé.
 Canapés relax avec mécanisme qui permet la sortie en avant des coussins d'assise.

The new deep elements Hills featured in this catalogue complete the Hills collection widely shown in the catalogue 09/10.
 4 sofas + 41 modular elements + 2 sofas with bed + 3 relax sofas + 3 ottomans
 Wooden frame with elastic straps, with pad in expanded polyurethane, upholstered with feather mattress.
 Backrest feather cushions upholstered in cotton.
 Seat feather cushions with insert in expanded polyurethane, with differentiated density, upholstered in cotton and heavy cotton.
 Feet in metal, powder coated, with anti-skid ferrule.
 Elements upholstered in completely removable fabric; elements upholstered in leather with cushions having removable covers and structure with non-removable covers. Backrest cushions ready for being fitted with a headrest adjustment device (the device is optional).
 Sofa beds with electrically welded spring and orthopaedic expanded mattress.
 Relax sofas with mechanism enabling seat cushions to move forwards.

Die in diesem Katalog gezeigten neuen Tiefelemente Hills ergänzen die Hills Kollektion, die weithin im Katalog 09/10 erscheint.
 4 Sofas + 41 Anbauelemente + 2 Sofabetten + 3 Relaxsofas + 3 Hocker
 Basisstruktur aus Holz mit elastischen Riemen, Schaumstoffpuffer und Daunenmatten-Überzug.
 Rückenissen in Daune mit Baumwollbezug.
 Sitzkissen aus Daunen mit Einsatz aus Polyurethanschaumstoff zu unterschiedlichen Anteilen und passendem Baumwollbezug.
 Pulverbeschichtete Metallfüße mit rutschfester Spitze.
 Elemente mit Stoffbezug vollständig abziehbar; Elemente mit Lederbezug mit abziehbaren Polstern und nicht abziehbarem Gestell.
 Die Rückenissen sind für die Einfügung von ein Rahmen zur Kopfstützeregulierung vorbereitet; der Rahmen ist ein Optional.
 Sofabetten mit elektrogewweißtem Sprungrahmen und orthopädischem Schaumstoffmatratze.
 Relaxsofas mit Verstellmechanismus, der ermöglicht die Sitzkissen ausziehen.

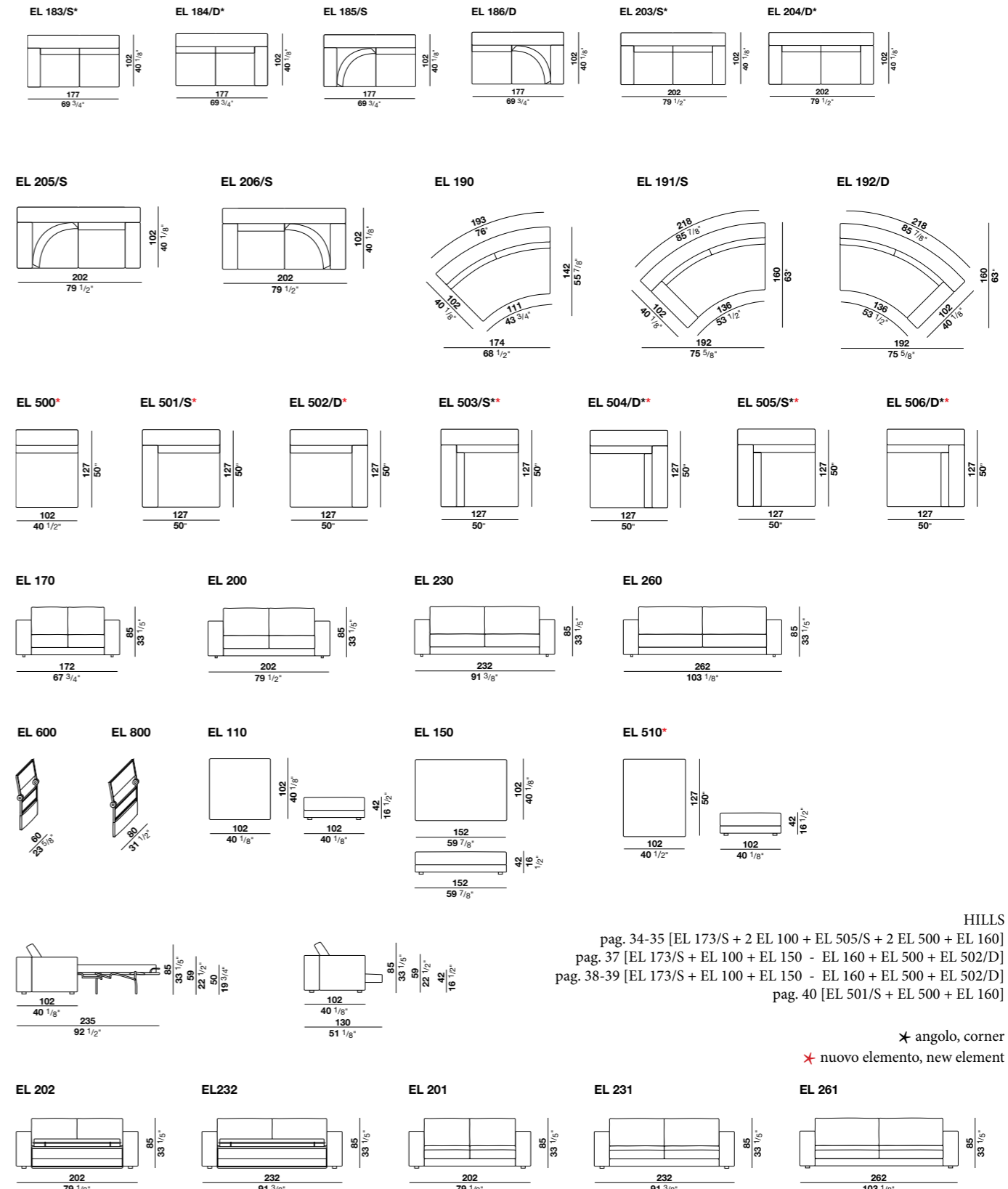
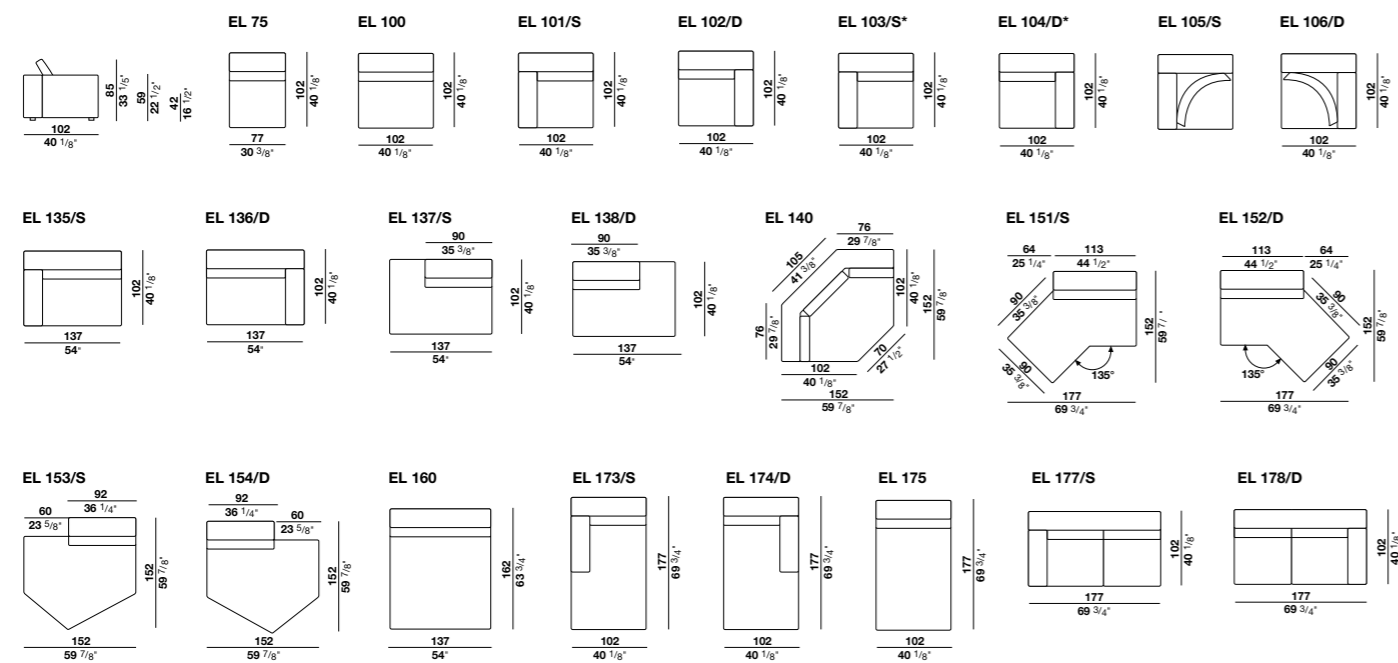

HILLS
 pag. 34-35 [EL 173/S + 2 EL 100 + EL 505/S + 2 EL 500 + EL 160]
 pag. 37 [EL 173/S + EL 100 + EL 150 - EL 160 + EL 500 + EL 502/D]
 pag. 38-39 [EL 173/S + EL 100 + EL 150 - EL 160 + EL 500 + EL 502/D]
 pag. 40 [EL 501/S + EL 500 + EL 160]

★ angolo, corner
 ✱ nuovo elemento, new element

Design Francesco Lucchese

I nuovi elementi profondi Hills fotografati nel presente catalogo completano la collezione Hills contenuta nel catalogo 09/10.

4 divani + 41 elementi componibili + 2 divani letto + 3 divani relax + 3 pouf
Struttura in legno con cinghie elastiche, con tamponi in poliuretano espanso, rivestita con materassina in piuma.

Cuscini schienale in piuma rivestiti in cotone.

Cuscini seduta in piuma con inserto in poliuretano espanso, a quote differenziate, rivestiti in cotone e cotone accoppiato.

Piedini in metallo verniciati a polvere, con puntale antiscivolo.

Elementi rivestiti in tessuto completamente sfoderabili; elementi rivestiti in pelle con cuscinate sfoderabile e struttura non sfoderabile.

Cuscini di schienale predisposti per l'inserimento di un telaio che consente la regolazione del poggiatesta. Il telaio è opzionale.

Divano letto con rete elettrosaldata e materasso ortopedico in espanso. Divano con movimento relax che permette la fuoriuscita del cuscino di seduta.

Les nouveaux éléments profonds Hills montrés dans ce catalogue complètent la collection Hills qui figure largement dans le catalogue 09/10.

4 canapés + 41 éléments composables + 2 canapés avec lit + 3 canapés relax + 3 poufs. Structure en bois, courroies élastiques, tampon en polyuréthane expansé, revêtue d'un matelassé en plume.

Coussins du dossier en plume revêtus coton.

Coussins de l'assise en plume et polyuréthane expansé, à niveaux différenciés, revêtus coton et coton compensé.

Pieds en métal vernis à poudre, avec système antidérapage.

Éléments revêtus de tissu, entièrement déhoussables; éléments revêtus en cuir, coussins entièrement déhoussables, structure non déhoussable. Coussins dossiers disposés pour l'insertion d'un châssis pour le règlement de l'appuie-tête. Le châssis est en option.

Canapés-lits avec sommier électro-soudé et matelas orthopédique en expansé.

Canapés relax avec mécanisme qui permet la sortie en avant des coussins d'assise.

The new deep elements Hills featured in this catalogue complete the Hills collection widely shown in the catalogue 09/10.

4 sofas + 41 modular elements + 2 sofas with bed + 3 relax sofas + 3 ottomans
Wooden frame with elastic straps, with pad in expanded polyurethane, upholstered with feather mattress.

Backrest feather cushions upholstered in cotton.

Seat feather cushions with insert in expanded polyurethane, with differentiated density, upholstered in cotton and heavy cotton.

Feet in metal, powder coated, with anti-skid ferrule.

Elements upholstered in completely removable fabric; elements upholstered in leather with cushions having removable covers and structure with non-removable covers. Backrest cushions ready for being fitted with a headrest adjustment device (the device is optional).

Sofa beds with electrically welded spring and orthopaedic expanded mattress. Relax sofas with mechanism enabling seat cushions to move forwards.

Sofa beds with electrically welded spring and orthopaedic expanded mattress. Relax sofas with mechanism enabling seat cushions to move forwards.

Die in diesem Katalog gezeigten neuen Tiefelemente Hills ergänzen die Hills Kollektion, die weithin im Katalog 09/10 erscheint.

4 Sofas + 41 Anbauelemente + 2 Sofabetten + 3 Relaxsofas + 3 Hocker
Basisstruktur aus Holz mit elastischen Riemen, Schaumstoffpuffer und Daunenmatten-Überzug.

Rückenkissen in Daune mit Baumwollbezug.

Sitzkissen aus Daunen mit Einsatz aus Polyurethanschaumstoff zu unterschiedlichen Anteilen und passendem Baumwollbezug.

Pulverbeschichtete Metallfüße mit rutschfester Spitze.

Elemente mit Stoffbezug vollständig abziehbar; Elemente mit Lederbezug mit abziehbaren Polstern und nicht abziehbarem Gestell.

Die Rückenkissen sind für die Einfügung von ein Rahmen zur Kopfstützerregulierung vorbereitet; der Rahmen ist ein Optional.

Sofabetten mit elektrogeschweißtem Sprungrahmen und orthopädischem Schaumstoffmatratze.

Relaxsofas mit Verstellmechanismus, der ermöglicht die Sitzkissen ausziehen.

HOST extra deep

Design Francesco Lucchese

I nuovi elementi profondi Hills fotografati nel presente catalogo completano la collezione Hills contenuta nel catalogo 09/10.
 4 divani + 41 elementi componibili + 2 divani letto + 3 divani relax + 3 pouf
 Struttura in legno con cinghie elastiche, con tamponi in poliuretano espanso, rivestita con materassina in piuma.
 Cuscini schienale in piuma rivestiti in cotone.
 Cuscini seduta in piuma con inserto in poliuretano espanso, a quote differenziate, rivestiti in cotone e cotone accoppiato.
 Piedini in metallo verniciati a polvere, con puntale antiscivolo.
 Elementi rivestiti in tessuto completamente sfoderabili; elementi rivestiti in pelle con cuscinate sfoderabile e struttura non sfoderabile.
 Cuscini di schienale predisposti per l'inserimento di un telaio che consente la regolazione del poggiatesta. Il telaio è opzionale.
 Divano letto con rete elettrosaldata e materasso ortopedico in espanso. Divano con movimento relax che permette la fuoriuscita del cuscino di seduta.

Les nouveaux éléments profonds Hills montrés dans ce catalogue complètent la collection Hills qui figure largement dans le catalogue 09/10.
 4 canapés + 41 éléments composables + 2 canapés avec lit + 3 canapés relax + 3 poufs. Structure en bois, courroies élastiques, tampon en polyuréthane expansé, revêtue d'un matelassé en plume.
 Coussins du dossier en plume revêtus coton.
 Coussins de l'assise en plume et polyuréthane expansé, à niveaux différenciés, revêtus coton et coton compensé.
 Pieds en métal vernis à poudre, avec système antidérapage.
 Éléments revêtus de tissu, entièrement déhoussables; éléments revêtus en cuir, coussins entièrement déhoussables, structure non déhoussable. Coussins dossiers disposés pour l'insertion d'un châssis pour le règlement de l'appuie-tête. Le châssis est en option.
 Canapés-lits avec sommier électro-soudé et matelas orthopédique en expansé.
 Canapés relax avec mécanisme qui permet la sortie en avant des coussins d'assise.

The new deep elements Hills featured in this catalogue complete the Hills collection widely shown in the catalogue 09/10.
 4 sofas + 41 modular elements + 2 sofas with bed + 3 relax sofas + 3 ottomans
 Wooden frame with elastic straps, with pad in expanded polyurethane, upholstered with feather mattress.
 Backrest feather cushions upholstered in cotton.
 Seat feather cushions with insert in expanded polyurethane, with differentiated density, upholstered in cotton and heavy cotton.
 Feet in metal, powder coated, with anti-skid ferrule.
 Elements upholstered in completely removable fabric; elements upholstered in leather with cushions having removable covers and structure with non-removable covers. Backrest cushions ready for being fitted with a headrest adjustment device (the device is optional).
 Sofa beds with electrically welded spring and orthopaedic expanded mattress.
 Relax sofas with mechanism enabling seat cushions to move forwards.

Die in diesem Katalog gezeigten neuen Tiefelemente Hills ergänzen die Hills Kollektion, die weithin im Katalog 09/10 erscheint.
 4 Sofas + 41 Anbauelemente + 2 Sofabetten + 3 Relaxsofas + 3 Hocker
 Basisstruktur aus Holz mit elastischen Riemen, Schaumstoffpuffer und Daunenmatten-Überzug.
 Rückenissen in Daune mit Baumwollbezug.
 Sitzkissen aus Daunen mit Einsatz aus Polyurethanschaumstoff zu unterschiedlichen Anteilen und passendem Baumwollbezug.
 Pulverbeschichtete Metallfüße mit rutschfester Spitze.
 Elemente mit Stoffbezug vollständig abziehbar; Elemente mit Lederbezug mit abziehbaren Polstern und nicht abziehbarem Gestell.
 Die Rückenissen sind für die Einfügung von ein Rahmen zur Kopfstützerregulierung vorbereitet; der Rahmen ist ein Optional.
 Sofabetten mit elektrogeschweißtem Sprungrahmen und orthopädischem Schaumstoffmatratze.
 Relaxsofas mit Verstellmechanismus, der ermöglicht die Sitzkissen ausziehen.

Design ludovica+roberto palomba

27 elementi componibili + 5 elementi singoli + 1 pouf + 8 tavolini.
Struttura in legno multistrato di pioppo e betulla con cinghie elastiche con tampone in poliuretano espanso, rivestito in fibra accoppiata con maglina. Cuscini di seduta in piuma, con inserto in poliuretano espanso a quote differenziate, rivestiti in cotone e cotone accoppiato. Cuscini schienale, poggiaresi e cuscini bracciolo in piuma e conforel rivestiti in cotone.

Piedini in alluminio pressofuso con puntale anticivolo disponibili cromati o verniciati a polvere colore RAL 9017(nero traffico) e RAL 9001 (crema). Elementi rivestiti in tessuto completamente sfoderabili; elementi rivestiti in pelle con cuscineria sfoderabile e struttura non sfoderabile.

Tavolini laccati: in MDF con finitura laccata lucida nei colori RAL 9017 (nero traffico), 9016 (bianco traffico) o 9001 (bianco crema) con piedini in alluminio pressofuso con puntale anticivolo disponibili nella finitura cromata oppure verniciata a polvere colore 9017(nero traffico) e RAL 9001 (crema). Tavolini in marmo: Piano in marmo bianco Carrara con piedini in alluminio pressofuso con puntale anticivolo disponibili nella finitura cromata oppure verniciata a polvere colore RAL 9017(nero traffico) e RAL 9001 (crema).

27 éléments composables + 5 éléments indépendants + 1 pouf + 8 petites tables
Structure en bois multicouche de peuplier et bouleau, courroies élastiques, tampon en polyuréthane expansé, revêtu de fibre unie à de la maille fine.

Coussins de l'assise en plume avec insert en polyuréthane expansé, à niveaux différenciés, revêtus coton et coton compensé.

Coussins du dossier, coussins lombaires et coussins accouider en plume et conforel revêtus coton. Pieds en aluminium moulé sous pression avec finition chromé ou verni à poudre dans les couleurs RAL 9017 (noir signalisation) et 9001 (blanc crème), avec système anti-dérapant.

Éléments revêtus de tissu, entièrement déhoussables; éléments revêtus en cuir, coussins entièrement déhoussables, structure non déhoussable.

Petites tables laquées: en MDF finition laquée brillante dans les couleurs RAL 9017 (noir signalisation) 9016 (blanc signalisation) et 9001 (blanc crème) et pieds en aluminium moulé avec finition chromé ou verni à poudre dans les couleurs RAL 9017 (noir signalisation) et 9001 (blanc crème), avec système anti-dérapant. Petites tables en marbre: Dessus en marbre blanc Carrara. Pieds en aluminium moulé sous pression avec finition chromé ou verni à poudre dans les couleurs RAL 9017 (noir signalisation) et 9001 (blanc crème), avec système anti-dérapant.

27 modular elements + 5 individual elements + 1 ottoman + 8 small tables
Wooden frame in multi-layer poplar and multi-layer birch with elastic straps, with pad in expanded polyurethane, fibre covering matched with jersey. Seat cushions in feather, with insert in expanded polyurethane, with differentiated density, upholstered in cotton and heavy cotton. Backrest cushions, lumbar cushions and armrest cushions in feather and conforel, upholstered in cotton. Die-cast aluminium feet with chrome-plated or powder coated finish (RAL colours 9017 black traffic or 9001 cream) and non-slip base.

Elements upholstered in completely removable fabric; elements upholstered in leather with cushions having removable covers and structure with non-removable covers.

Small tables EL.400-410-420: tops in MDF glossy lacquered in the RAL colours 9017(black traffic), 9016 (white traffic) or 9001 (cream). Die-cast aluminium feet with chrome-plated or powder coated finish (RAL colours 9017 black traffic or 9001 cream) and non-slip base. Small tables EL.450-460-470-480-490: tops in white Carrara marble. Die-cast aluminium feet with chrome-plated or powder coated finish (RAL colours 9017 black traffic or 9001 cream) and non-slip base.

27 Anbauelemente + 5 Einzelemente +1 Hocker + 8 Tischchen
Basisstruktur aus Pappel- und Birke-Multiplexplatte mit elastischen Gurten, Schaumstoffpuffern und Faser/Trikotbezug.

Sitzkissen aus Daunen mit Einsatz aus Polyurethanschaumstoff zu unterschiedlichen Anteilen und passendem Faser/Baumwollbezug.

Rücken-, Lenden- und Armlehnekissen aus Daune und Conforel mit Baumwollbezug. Füße aus Aluminiumdruckguss mit rutschfester Spitze in drei Ausführungen: verchromt, pulverbeschichtet RAL 9017(Verkehrsschwarz), oder pulverbeschichtet RAL 9001(Cremeweiß).

Elemente mit Stoffbezug vollständig abziehbar; Elemente mit Lederbezug mit abziehbaren Polstern und nicht abziehbarem Gestell.

Lackierten Tischchen: aus MDF glänzend lackiert, RAL Farben 9017 (Verkehrsschwarz), 9016 (Verkehrsweiß) oder 9001 (Cremeweiß), mit Füße aus Aluminiumdruckguss mit rutschfester Spitze in drei Ausführungen: verchromt, pulverbeschichtet RAL 9017(Verkehrsschwarz), oder pulverbeschichtet RAL 9001(Cremeweiß). Marmortischchen: Platten aus Carrara weißem Marmor mit Füße aus Aluminiumdruckguss mit rutschfester Spitze in drei Ausführungen: verchromt, pulverbeschichtet RAL 9017(Verkehrsschwarz), oder pulverbeschichtet RAL 9001(Cremeweiß).

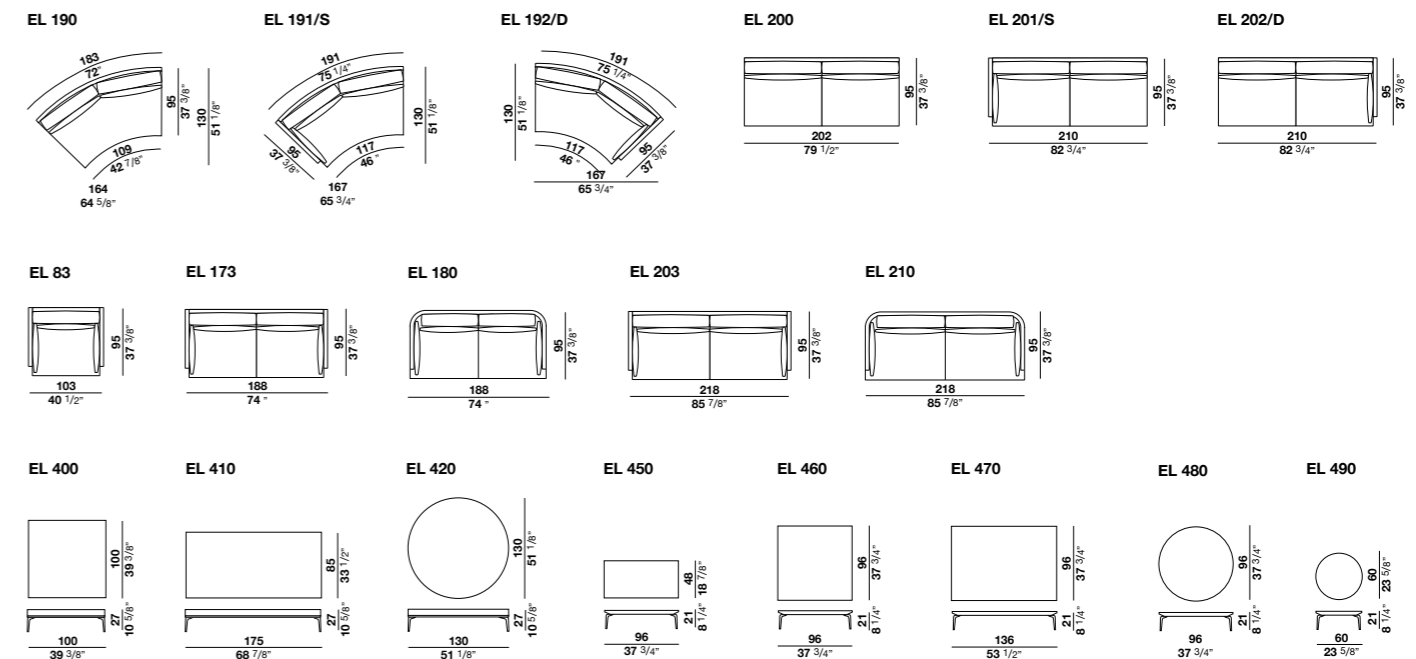

KONG
pag. 4 [EL 171/S + EL 89/S + EL 170 + EL 178/D]
pag. 6 [EL 210 - EL 171/S + EL 178/D]
pag. 7 [EL 179/S + EL 172/D]
pag. 8 [EL 201/S + EL 178/D]
pag. 10 [EL 151/S + 2 EL 190 + EL 150/D]
pag. 11 [EL 151/S + EL 200 + EL 178/D]
pag. 12-13 [EL 210 - EL 171/S + EL 178/D]

HILLY table

Design ludovica+roberto palomba

4 tavolini
Piani in MDF. Gambe in legno di faggio.
Finitura lucida nei colori rosso (RAL 3003 / NCS 3163 Y97R) e mastice chiaro (NCS S2005 Y20R).

4 small tables
Structure in MDF and legs in beechwood.
Bright lacquered finishes available: red colour (RAL 3003 / NCS 3163 Y97R) and dove colour (NCS S2005 Y20R).

4 petites tables
Structure en MDF et pieds en hêtre.
Finition laquée brillante dans les couleurs rouge (RAL 3003 / NCS 3163 Y97R) et tourterelle (NCS S2005 Y20R).

4 Tischchen
Platten aus MDF und Beinen aus Buchenholz.
Fertigung: glänzend lackiert in rote Farbe (RAL 3003 / NCS 3163 Y97R) oder taube Farbe (NCS S2005 Y20R).

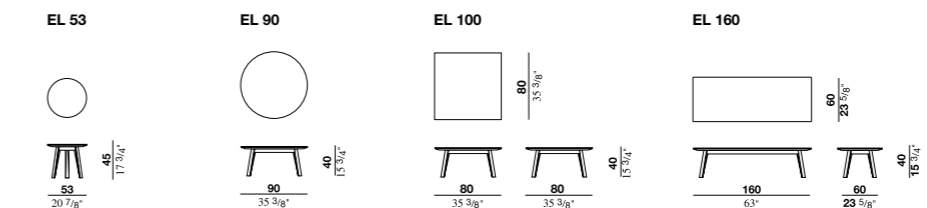

Design ludovica+roberto palomba

4 divani + 1 pouff

Struttura in legno con cinghie elastiche, con tampono in poliuretano espanso, rivestita con materassina in piuma.

Cuscini seduta in piuma con inserto in poliuretano espanso, a quote differenziate, rivestiti in cotone e cotone accoppiato.

Cuscini schienale in piuma rivestiti in cotone.

Base in metallo verniciato a polvere colore brown-bronze o cromato con puntale antiscivolo. Elementi rivestiti in tessuto completamente sfoderabili; elementi rivestiti in pelle con cuscineria sfoderabile e struttura non sfoderabile.

4 canapés + 1 pouf.

Structure en bois, courroies élastiques, tampon en polyuréthane expansé, revêtue d'un matelassé en plume.

Coussins de l'assise en plume et polyuréthane expansé, à niveaux différenciés, revêtus coton et coton compensé.

Coussins du dossier en plume revêtus coton.

Base en métal verni à poudre couleur brun-bronze ou chromé, système antidérapage.

Éléments revêtus de tissu, entièrement déhoussables; éléments revêtus en cuir, coussins entièrement déhoussables, structure non déhoussable.

4 sofas + 1 ottoman

Wooden frame with elastic straps, with pad in expanded polyurethane, upholstered with feather mattress.

Seat feather cushions with insert in expanded polyurethane, with differentiated density, upholstered in cotton and heavy cotton.

Backrest feather cushions upholstered in cotton.

Base in powder coated metal (colour brown bronze) or chrome-plated metal with anti-skid ferrule.

Elements upholstered in completely removable fabric; elements upholstered in leather with cushions having removable covers and structure with non-removable covers.

4 Sofas + 1 Hocker

Basisstruktur aus Holz mit elastischen Riemen, Schaumstoffpuffer und Daunenmatten-Überzug.

Sitzkissen aus Daunen mit Einsatz aus Polyurethanschaumstoff zu unterschiedlichen Anteilen und passendem Baumwollbezug.

Rückenkissen aus Daunen mit Baumwollbezug.

Basis aus braun-bronzefarbigem pulverbeschichtetem Metall oder aus verchromtem Metall mit rutschfester Spitze.

Elemente mit Stoffbezug vollständig abziehbar; Elemente mit Lederbezug mit abziehbaren Polstern und nicht abziehbarem Gestell.

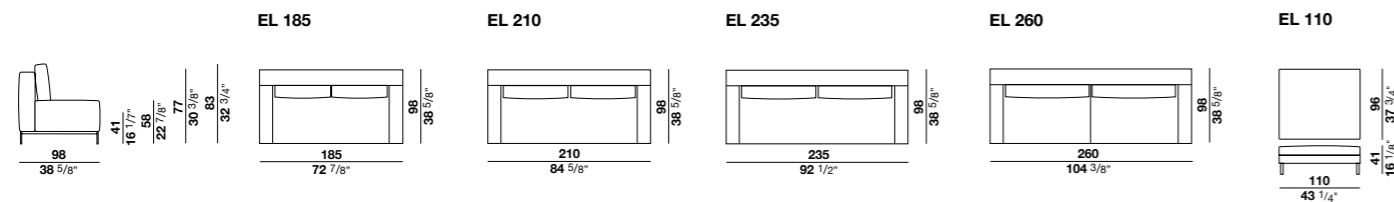

Design Francesco Lucchese

I nuovi elementi profondi Hills fotografati nel presente catalogo completano la collezione Hills contenuta nel catalogo 09/10.

4 divani + 41 elementi componibili + 2 divani letto + 3 divani relax + 3 pouf
Struttura in legno con cinghie elastiche, con tampono in poliuretano espanso, rivestita con materassina in piuma.

Cuscini schienale in piuma rivestiti in cotone.

Cuscini seduta in piuma con inserto in poliuretano espanso, a quote differenziate, rivestiti in cotone e cotone accoppiato.

Piedini in metallo verniciati a polvere, con puntale antiscivolo.

Elementi rivestiti in tessuto completamente sfoderabili; elementi rivestiti in pelle con cuscineria sfoderabile e struttura non sfoderabile.

Cuscini di schienale predisposti per l'inserimento di un telaio che consente la regolazione del poggiatesta. Il telaio è opzionale.

Divano letto con rete elettrosaldata e materasso ortopedico in espanso. Divano con movimento relax che permette la fuoriuscita del cuscino di seduta.

The new deep elements Hills featured in this catalogue complete the Hills collection widely shown in the catalogue 09/10.

4 sofas + 41 modular elements + 2 sofas with bed + 3 relax sofas + 3 ottomans
Wooden frame with elastic straps, with pad in expanded polyurethane, upholstered with feather mattress.

Backrest feather cushions upholstered in cotton.

Seat feather cushions with insert in expanded polyurethane, with differentiated density, upholstered in cotton and heavy cotton.

Feet in metal, powder coated, with anti-skid ferrule.

Elements upholstered in completely removable fabric; elements upholstered in leather with cushions having removable covers and structure with non-removable covers. Backrest cushions ready for being fitted with a headrest adjustment device (the device is optional).

Sofa beds with electrically welded spring and orthopaedic expanded mattress.

Relax sofas with mechanism enabling seat cushions to move forwards.

Les nouveaux éléments profonds Hills montrés dans ce catalogue complètent la collection Hills qui figure largement dans le catalogue 09/10.

4 canapés + 41 éléments composables + 2 canapés avec lit + 3 canapés relax + 3 poufs. Structure en bois, courroies élastiques, tampon en polyuréthane expansé, revêtue d'un matelassé en plume.

Coussins du dossier en plume revêtus coton.

Coussins de l'assise en plume et polyuréthane expansé, à niveaux différenciés, revêtus coton et coton compensé.

Pieds en métal vernis à poudre, avec système antidérapage.

Éléments revêtus de tissu, entièrement déhoussables; éléments revêtus en cuir, coussins entièrement déhoussables, structure non déhoussable.

Coussins dossiers disposés pour l'insertion d'un châssis pour le règlement de l'appuie-tête. Le châssis est en option.

Canapés-lits avec sommier électro-soudé et matelas orthopédique en expansé.

Canapés relax avec mécanisme qui permet la sortie en avant des coussins d'assise.

Die in diesem Katalog gezeigten neuen Tiefelemente Hills ergänzen die Hills Kollektion, die weithin im Katalog 09/10 erscheint.

4 Sofas + 41 Anbauelemente + 2 Sofabetten + 3 Relaxsofas + 3 Hocker
Basisstruktur aus Holz mit elastischen Riemen, Schaumstoffpuffer und Daunenmatten-Überzug.

Rückenkissen in Daune mit Baumwollbezug.

Sitzkissen aus Daunen mit Einsatz aus Polyurethanschaumstoff zu unterschiedlichen Anteilen und passendem Baumwollbezug.

Pulverbeschichtete Metallfüße mit rutschfester Spitze.

Elemente mit Stoffbezug vollständig abziehbar; Elemente mit Lederbezug mit abziehbaren Polstern und nicht abziehbarem Gestell.

Die Rückenkissen sind für die Einfügung von ein Rahmen zur Kopfstützeregulierung vorbereitet; der Rahmen ist ein Optional.

Sofabetten mit elektrogeschweißtem Sprungrahmen und orthopädischem Schaumstoffmatratze.

Relaxsofas mit Verstellmechanismus, der ermöglicht die Sitzkissen ausziehen.

Design Francesco Lucchese

4 divani + 1 pouff

Struttura in legno con cinghie elastiche, con tamponi in poliuretano espanso, rivestita con materassina in piuma.

Cuscini seduti in piuma con inserto in poliuretano espanso, a quote differenziate, rivestiti in cotone e cotone accoppiato.

Cuscini schienali in piuma rivestiti in cotone.

Base in metallo verniciato a polvere colore brown-bronze o cromato con puntale antiscivolo. Elementi rivestiti in tessuto completamente sfoderabili; elementi rivestiti in pelle con cuscineria sfoderabile e struttura non sfoderabile.

4 sofas + 1 ottoman

Wooden frame with elastic straps, with pad in expanded polyurethane, upholstered with feather mattress.

Seat feather cushions with insert in expanded polyurethane, with differentiated density, upholstered in cotton and heavy cotton.

Backrest feather cushions upholstered in cotton.

Base in powder coated metal (colour brown bronze) or chrome-plated metal with anti-skid ferrule.

Elements upholstered in completely removable fabric; elements upholstered in leather with cushions having removable covers and structure with non-removable covers.

4 canapés + 1 pouf.

Structure en bois, courroies élastiques, tampon en polyuréthane expansé, revêtue d'un matelassé en plume.

Coussins de l'assise en plume et polyuréthane expansé, à niveaux différenciés, revêtus coton et coton compensé.

Coussins du dossier en plume revêtus coton.

Base en métal verni à poudre couleur brun-bronze ou chromé, système antidérapage.

Éléments revêtus de tissu, entièrement déhoussables; éléments revêtus en cuir, coussins entièrement déhoussables, structure non déhoussable.

4 Sofas + 1 Hocker

Basisstruktur aus Holz mit elastischen Riemen, Schaumstoffpuffer und Daunematten-Überzug.

Sitzkissen aus Daunen mit Einsatz aus Polyurethanschaumstoff zu unterschiedlichen Anteilen und passendem Baumwollbezug.

Rückenkissen aus Daunen mit Baumwollbezug.

Basis aus braun-bronzefarbigem pulverbeschichtetem Metall oder aus verchromtem Metall mit rutschfester Spitze.

Elemente mit Stoffbezug vollständig abziehbar; Elemente mit Lederbezug mit abziehbaren Polstern und nicht abziehbarem Gestell.

Design ludovica+roberto palomba

27 elementi componibili + 5 elementi singoli + 1 pouf.

8 elementi con letto per uso occasionale.

Struttura in legno multistrato di pino e betulla con cinghie elastiche con tamponi in poliuretano espanso, rivestito in fibra accoppiata con maglina. Cuscini di seduta in poliuretano espanso a quote differenziate, rivestiti in fibra accoppiata cotone.

Cuscini schienali, poggiatesta e braccioli in piuma e conforel rivestiti in cotone.

Piedini in metallo verniciati a polvere, con puntale antiscivolo.

Elementi con letto provvisti di meccanismo a 3 pieghe, rete elettrosaldata, materasso in espanso HR30 spessore 6 cm. circa

Elementi rivestiti in tessuto completamente sfoderabili; elementi rivestiti in pelle con cuscineria sfoderabile e struttura non sfoderabile.

27 modular elements + 5 individual elements + 1 ottoman

8 elements with bed for occasional use

Wooden frame in multi-layer poplar and multi-layer birch with elastic straps, with pad in expanded polyurethane, fibre covering matched with jersey. Seat cushions in expanded polyurethane, with differentiated density, fibre covering matched with jersey.

Backrest cushions, lumbar cushions and armrest cushions in feather and conforel, upholstered in cotton. Feet in metal, powder coated, with anti-skid ferrule. Elements with bed: 3-fold mechanism, electrically welded spring and about 6 cm. thick expanded mattress HR 30. Elements upholstered in completely removable fabric; elements upholstered in leather with cushions having removable covers and structure with non-removable covers.

Elementi con letto provvisti di meccanismo a 3 pieghe, rete elettrosaldata, materasso in espanso HR30 spessore 6 cm. circa

27 éléments composables + 5 éléments indépendants + 1 pouf

8 éléments munis de lit pour des occasions imprévues

Structure en bois multicouche de peuplier et bouleau, courroies élastiques, tampon en polyuréthane expansé, revêtue de fibre unie à de la maille fine. Coussins de l'assise en polyuréthane expansé, à niveaux différenciés, revêtus de fibre unie à du coton.

Coussins du dossier, coussins lombaires et coussins accouder en plume et conforel revêtus coton.

Pieds en métal verni à poudre avec système antidérapant.

Éléments avec lit avec mécanisme 3 plies, sommier électro-soudé, matelas en expansé HR 30 épaisseur cm. 6 environ.

Éléments revêtus de tissu: entièrement déhoussables; éléments revêtus en cuir: coussins entièrement déhoussables, structure non déhoussable.

27 Anbauelemente + 5 Einzelemente + 1 Hocker

8 Elemente verfügbar als Schlafsofa zur gelegentlichen Verwendung. Basisstruktur aus Pappel- und Birke-Multiplexplatte mit elastischen Gurten, Schaumstoffpuffern und Faser/Trikotbezug.

Sitzkissen aus Polyurethanschaumstoff zu unterschiedlichen Anteilen und passendem Faser/Baumwollbezug.

Rücken-, Lenden- und Armlehnekissen aus Daune und Conforel mit Baumwollbezug. Pulverbeschichtete Metallfüße mit rutschfester Spitze.

Elemente mit Bettversion ausgestattet mit Bettmechanismus 3 mal gefaltet, elektrogeschweißten Sprungrahmen und Schaumstoffmatratze HR 30 (Dicke cm. 6 ungefähr).

Elemente mit Stoffbezug vollständig abziehbar; Elemente mit Lederbezug mit abziehbaren Polstern und nicht abziehbarem Gestell.

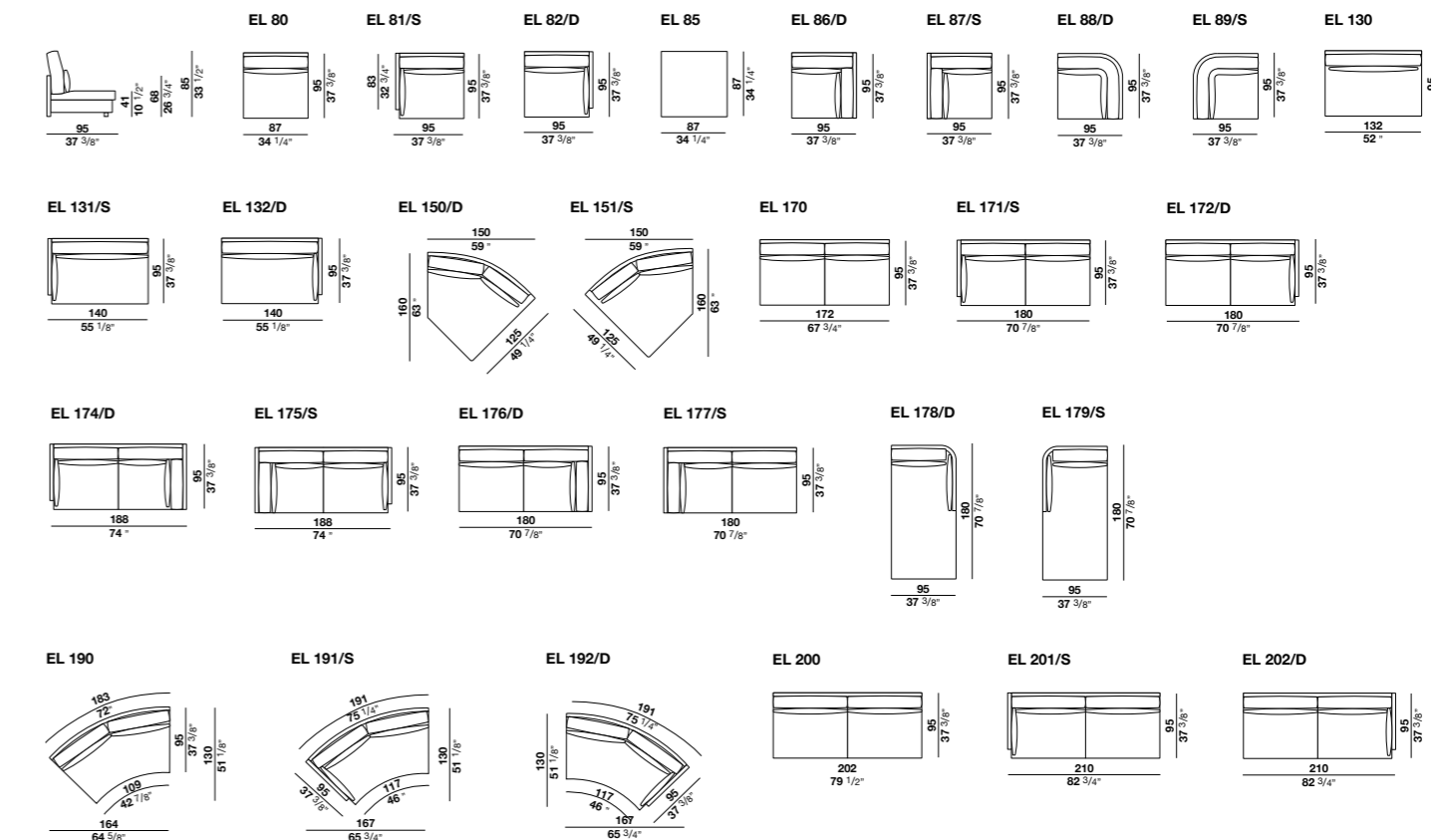

ZIP

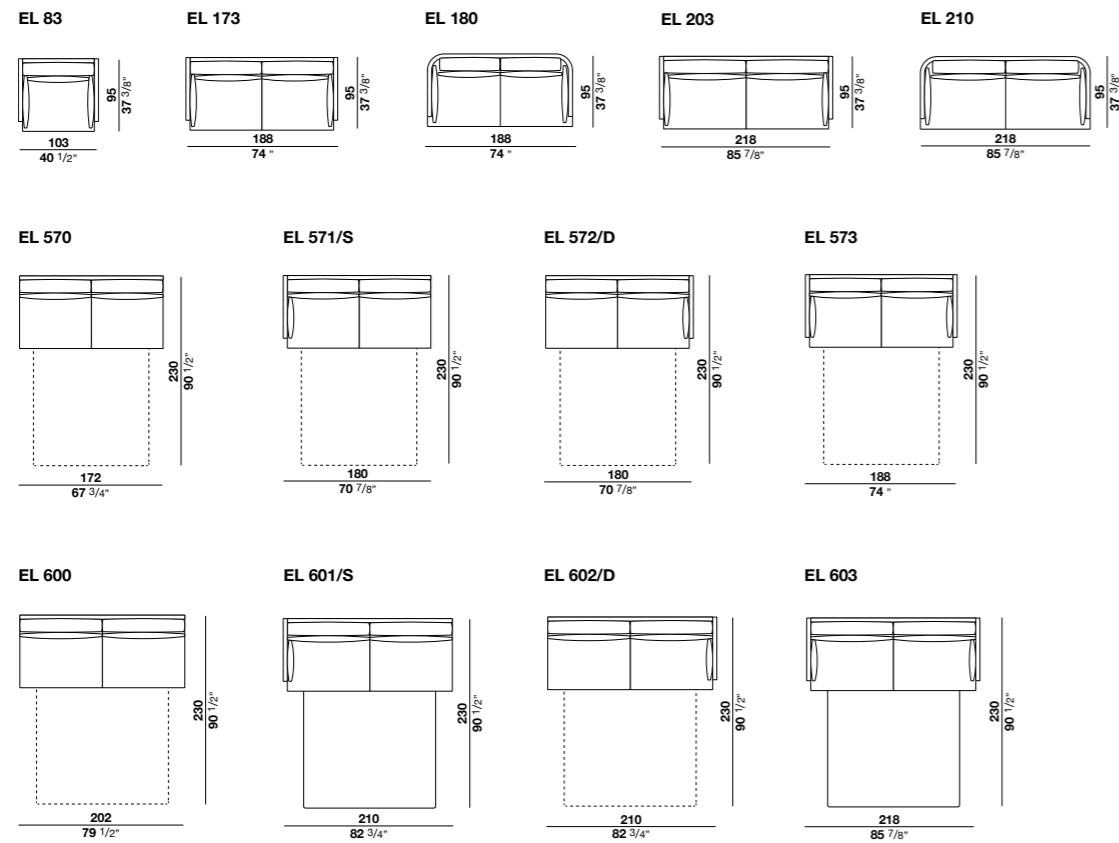

SHAN
 pag. 14 [EL 179/S + EL 170 + EL 89/S + EL 200 + EL 150/D]
 pag. 15 [EL 179/S + EL 200 + EL 150/D]
 pag. 16-17 [EL 179/S + EL 170 + EL 89/S + EL 200 + EL 150/D]
 pag. 19 [EL 171/S + 178/D]
 pag. 20-21 [EL 171/S + 178/D]
 pag. 22 [EL 171/S + 178/D]

Design ludovica+roberto palomba

19 elementi componibili + 5 elementi singoli + 1 pouf.
 Struttura in legno con cinghie elastiche e imbottitura in poliuretano espanso, rivestito in fibra accoppiata con vellutino.
 Braccioli con struttura in legno, imbottitura in poliuretano espanso e fibra 500 gr., rivestito con foderina in vellutino.
 Cuscini di seduta in poliuretano espanso a quote differenziate, rivestiti in fibra accoppiata con vellutino.
 Cuscini schienale integrati alla struttura, cinghiati, imbottiti in poliuretano espanso rivestiti in fibra accoppiata con vellutino.
 Piedini in legno di faggio tinti neri.
 Elementi rivestiti in tessuto e pelle completamente sfoderabili.
 Zip è dotato di braccioli completamente e facilmente smontabili dalla struttura, consentendo di trasformare in poche mosse una composizione destra in sinistra e viceversa.

19 éléments modulaires + 5 indépendants + 1 pouf
 Structure en bois. Courroies élastiques et rembourrage en polyuréthane expansé revêtu de fibre et toile compensée.
 Structure de l'accoudoir en bois, avec rembourrage en polyuréthane expansé et fibre 500 g, recouvert en toile compensée.
 Coussins d'assise en polyuréthane expansé à niveaux différenciés, recouverts de fibre jumelée avec toile compensée.
 Coussins dossiers intégrés à la structure, en polyuréthane expansé avec courroies élastiques, recouverts de fibre jumelée avec toile compensée.
 Pieds en hêtre teint noir.
 Éléments revêtus de tissu, entièrement déhoussables; éléments revêtus en cuir, entièrement déhoussables.
 L'accoudoir de Zip peut être complètement démonté de la structure afin de transformer facilement un canapé modulaire droit dans un canapé gauche et vice-versa.

19 modular elements + 5 individual elements + 1 ottoman
 Wooden frame with elastic straps, upholstered in expanded polyurethane, fibre covering matched with fine velveteen
 Armrest with wooden frame, upholstered in expanded polyurethane and fibre 500 gr., covered with velveteen.
 Seat cushions in expanded polyurethane, in different densities, fibre covering matched with velveteen.
 Backrest cushions, integrated into the structure in expanded polyurethane, with elastic straps, upholstered in fibre matched with fine velveteen.
 Feet in beech wood, painted black.
 Elements upholstered in completely removable fabric; elements upholstered in completely removable leather.
 The armrest of Zip can be easily disassembled from the structure, enabling to turn a right modular configuration into a left one and viceversa.

19 Anbauelemente + 5 Einzelemente + 1 Hocker
 Basisstruktur aus Holz mit elastischen Riemen. Polsterung aus Polyurethanschaumstoff und Faser/Samt Bezug.
 Armlehnenstruktur aus Holz mit Polsterung aus Polyurethanschaumstoff und Faser 500 gr., und Samtbezug.
 Sitzkissen aus Polyurethanschaumstoff zu unterschiedlichen Anteilen und Faser/Samtbezug.
 Die Rückenkissen aus Polyurethanschaumstoff und Faser/Samt Bezug sind in die Struktur integriert und haben elastische Riemen.
 Füße aus schwarz gefärbtem Buchenholz.
 Elemente mit Stoffbezug vollständig abziehbar; Elemente mit Lederbezug vollständig abziehbar.
 Die Armlehne Zip ist komplett und leicht zerlegbar von der Struktur, so kann man eine rechte Polstergarnitur zu einer linken Polstergarnitur – und umgekehrt – verwandeln.

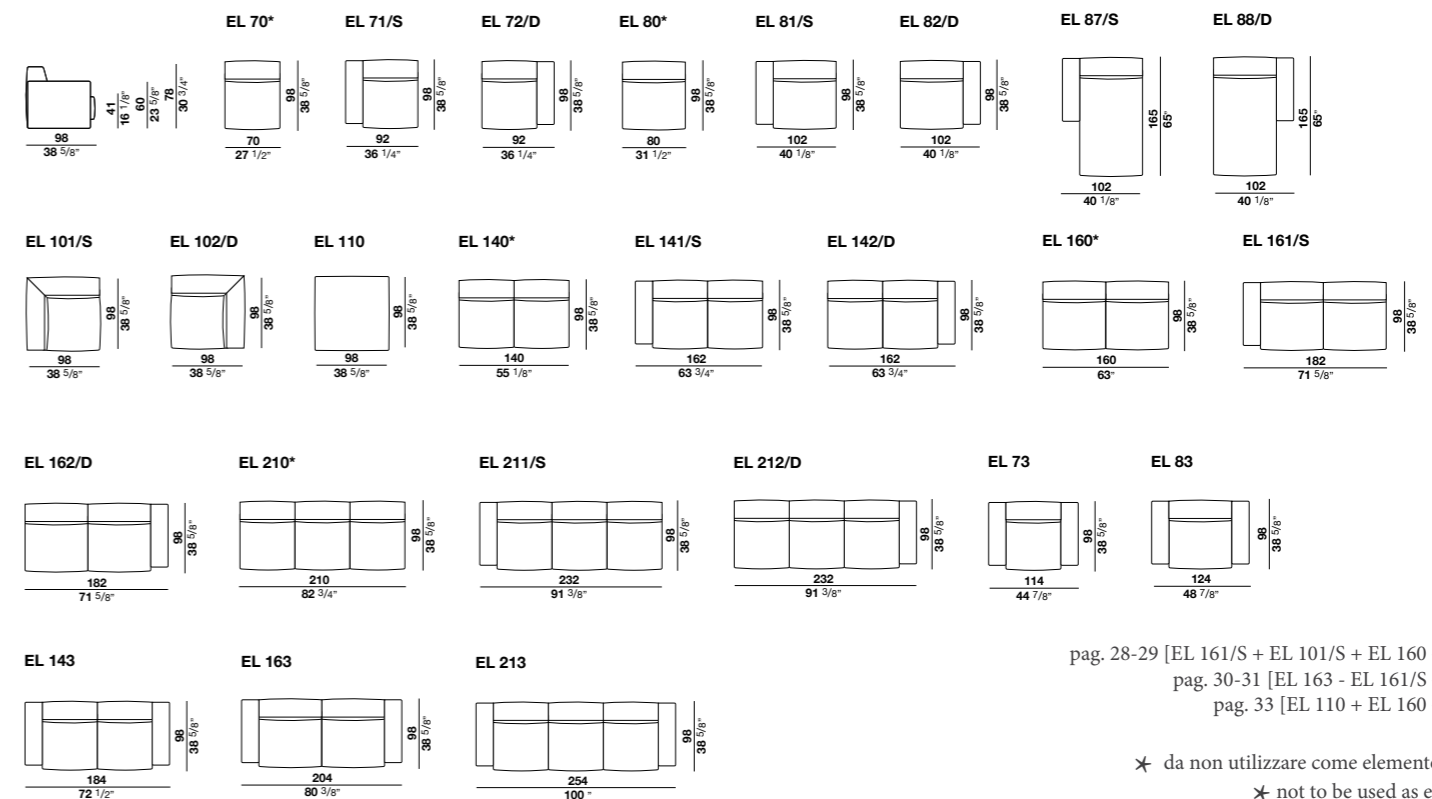

ZIP
 pag. 28-29 [EL 161/S + EL 101/S + EL 160 + EL 88/D]
 pag. 30-31 [EL 163 - EL 161/S + EL 88/D]
 pag. 33 [EL 110 + EL 160 + EL 88/D]

✘ da non utilizzare come elemento terminale
 ✘ not to be used as end element

Art Direction

Lucchesedesign

Photo

Matteo Imbriani

Max Zambelli

Walter Gumiero

Print

Thanks to

Salviati

Society



Swan Italia srl
Via Montenero 15, Cantù (CO) Italy

T +39 031 730 222
F +39 031 732 505

www.swanitaly.com
info@swanitaly.com