



Civilization of Beauty

Gres porcellanato colorato in massa · Full-body coloured porcelain stoneware
Grès cérame coloré dans la masse · In der Masse gefärbtes Feinsteinzeug
Gres porcelánico coloreado en masa · Окрашенный по всей толщине керамогранит · 多彩陶瓷

CA' FOSCARI

Antiche radici, spirito contemporaneo
Ancient roots, contemporary spirit





CA' FOSCARI

Antiche radici, spirito contemporaneo
Ancient roots, contemporary spirit

Gres porcellanato colorato in massa . Full-body coloured porcelain stoneware
Grès cérame coloré dans la masse . In der Masse gefärbtes Feinsteinzeug
Gres porcelánico coloreado en masa . Окрашенный по всей толщине керамогранит . 多彩陶瓷

Indoor



20x120 (8"x48") 10mm

Outdoor R11



20x120 (8"x48") 10mm R11
40x120 (16"x48") 20mm R11
40x80 (16"x31 1/2") 20mm R11



Con Ca' Foscari il grès porcellanato raggiunge nuovi traguardi sul terreno della ricerca stilistica e tecnica, facendo proprio il linguaggio ricco di fascino e poesia dei legni più pregiati.

Cinque colori fedeli alla materia di ispirazione, le cui grafiche riescono a dare risalto alle ambientazioni contemporanee ma anche agli spazi più classici.

Un'emozionante proposta che conquista per la propria sensibilità colta e, al tempo stesso, elegante.

CA' FOSCARI

Antiche radici, spirito contemporaneo
Ancient roots, contemporary spirit

indoor & outdoor surfaces

With Ca' Foscari, porcelain stoneware has reached new heights in style and engineering, taking on all the beauty, charm, and poetry of the finest timbers.

Five colours that are faithful to the materials on which the collection is based, and a print finish which draws out the best of both contemporary surroundings and more traditional settings.

An exciting proposal whose cultured awareness and elegance are guaranteed to win over users.

Avec Ca' Foscari, le grès cérame atteint de nouveaux objectifs dans le secteur de la recherche stylistique et technique, en adoptant le langage fascinant et poétique des bois les plus précieux.

Cinq couleurs fidèles à la matière d'inspiration dont le graphisme parvient à mettre en valeur les décors contemporains ainsi que les espaces les plus classiques.

Une proposition émouvante qui conquiert par sa sensibilité cultivée et élégante à la fois.

Mit Ca' Foscari erreicht das Feinsteinzeug neue Ziele im Bereich der stilistischen und technischen Entwicklung, indem es sich die an Reisen und Poesie reiche Sprache der edelsten Hölzer zu eigen macht.

Fünf der die Anregung bildenden Materie getreue Farben, deren Graphiken es gelingt, die zeitgenössischen Umgebungen aber auch die Räume im klassischen Stil hervorzuheben.

Ein aufregendes Angebot, das durch seine gehobene und gleichzeitig elegante Sensibilität überzeugt.

Con Ca' Foscari el gres porcelánico alcanza nuevos objetivos en el campo de la investigación estilística y técnica, adoptando el lenguaje rico en fascinación y poesía de las maderas más preciadas.

Todo ello en cinco colores fieles al material inspirador, cuyas gráficas logran valorizar las ambientaciones contemporáneas pero también los espacios más clásicos.

Una emocionante propuesta que encanta gracias a su propia sensibilidad culta y, simultáneamente, elegante.

В коллекции Ca' Foscari керамогранит осваивает новые рубежи в сфере стилистических и технических исследований, позаимствовав рисунок ценных пород дерева, богатых очарованием и поэзией.

Пять цветов коллекции достоверно воспроизводят вдохновляющий ее материал, а ее графические мотивы великолепно оформляют как современные, так и более классические пространства.

Это завораживающее предложение покориет своей интеллигентной и в то же время элегантно тонкостью.

与Ca' Foscari一道，陶瓷产品在式样和技术研究领域实现了新的目标，展现了最优质木材富有想象和诗意的语言。原材料的五种颜色，其图案能够最大程度地适应当代风格和经典风格的环境。凭借突出的敏锐和优雅，产生了富有感情的方案。



Civilization of Beauty

CA' FOSCARI

Antiche radici, spirito contemporaneo
Ancient roots, contemporary spirit

Gres porcellanato colorato in massa . Full-body coloured porcelain stoneware
Grès cérame coloré dans la masse . In der Masse gefärbtes Feinsteinzeug
Gres porcelánico coloreado en masa . Окрашенный по всей толщине керамогранит . 多彩陶瓷

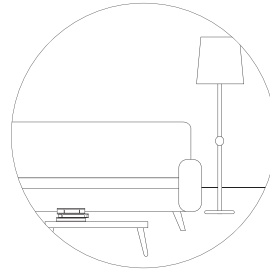

Indoor - 10mm

Naturale e rettificato

Natural and rectified. Naturel et rectifié. Natur Oberfläche und kalibriert.
Natural y rectificado. Натуральный ректифицированный. 天然改制.



lino



canapa



avana



tabacco



moro

20x120 (8"x48")

indoor: pag 8-23 . pag 28-29

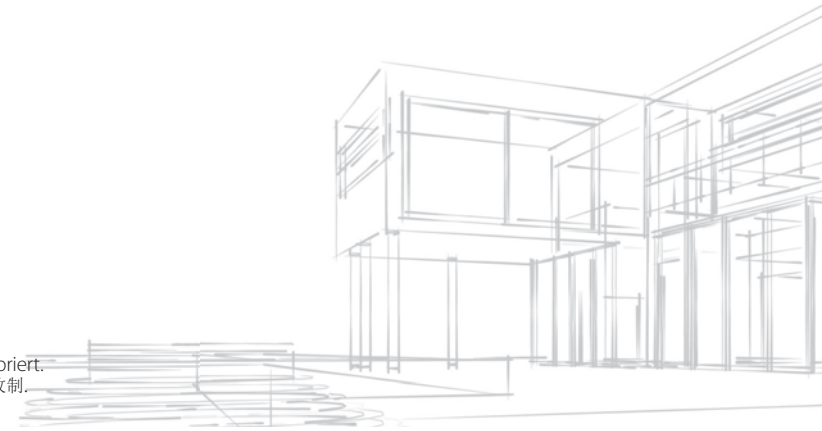

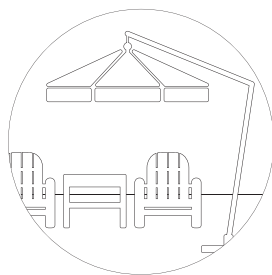

Outdoor R11 - 10mm, 20mm

Naturale e rettificato

Natural and rectified. Naturel et rectifié. Natur Oberfläche und kalibriert.
Natural y rectificado. Натуральный ректифицированный. 天然改制.



20x120 (8"x48") 10mm R11

40x120 (16"x48") 20mm R11 - 40x80 (16"x31 1/2") 20mm R11

outdoor: pag 24-27 . pag 30-39

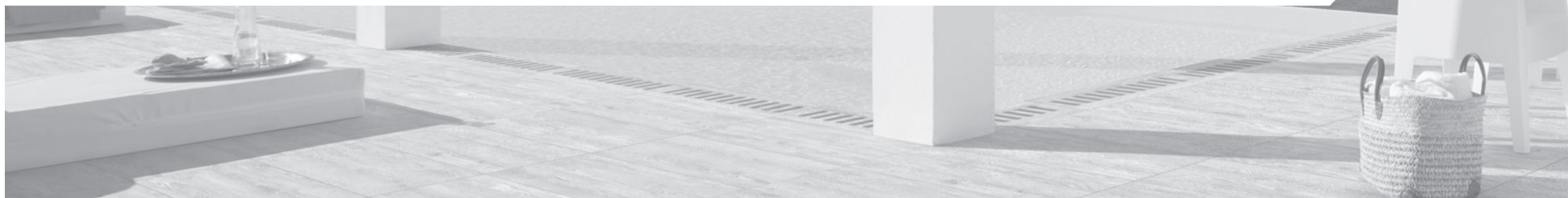

CA' FOSCARI indoor - 10mm

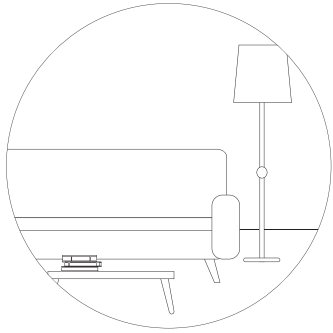

20x120 (8"x48")

Naturale e rettificato. Natural and rectified. Naturel et rectifié. Natur Oberfläche und kalibriert.
Natural y rectificado. Натуральный ректифицированный. 天然改制。

Spessore. Thickness. Epaisseur. Stärke. Espesor. Толщина. 层. **10 mm**



Contrasti che si completano. Un legno che trova la sua dimensione nel calore della classicità e nell'essenzialità del contemporaneo.

Complementary contrasts.
A wood which finds its
place in the warmth of
classical designs, as well
as the essential lines of
contemporary rooms.

Des contrastes qui se
complètent.
Un bois qui trouve sa
dimension dans la chaleur du
classique et dans l'essentialité
du contemporain.

Kontraste, die sich ergänzen.
Ein Holz, das seine Dimension
in der Wärme des Klassischen
und in der Wesentlichkeit des
Zeitgenössischen findet.

Contrastes que se
complementan.
Una madera que encuentra sus
dimensiones en el calor de lo
clásico y en la esencialidad de
lo contemporáneo.

Контрасты дополняют друг друга.
Материал под дерево находит
свое измерение в тепле классики
и в лаконичности современного
стиля.

完整的对比。木材的边界在于经典的
热量和当代的质量。



Civilization of Beauty

TABACCO 20x120 (8"x48") Nat. Ret.
Terrace: Tabacco 20x120 (8"x48") Nat. Ret. R11

indoor
outdoor



TABACCO 20x120 (8"x48") Nat. Ret.

indoor





TABACCO 20x120 (8"x48") Nat. Ret.

Terrace: Tabacco 20x120 (8"x48") Nat. Ret. R11

indoor

outdoor



TABACCO 20x120 (8"x48") Nat. Ret.

indoor



LINO 20x120 (8"x48") Nat. Ret.
Wallpaper: Bruma Natural (by AVA)

indoor





LINO 20x120 (8"x48") Nat. Ret.

indoor

CANAPA 20x120 (8"x48") Nat. Ret.

indoor





CANAPA 20x120 (8"x48") Nat. Ret.

indoor



AVANA 20x120 (8"x48") Nat. Ret.

indoor





MORO 20x120 (8"x48") Nat. Ret.

indoor





CA' FOSCARI

outdoor R11 - 10mm, 20mm

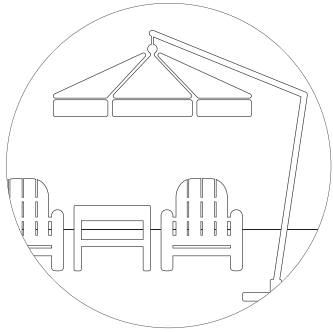

20x120 (8"x48") 10mm R11

Spessore. Thickness. Epaisseur. Stärke. Espesor. Толщина. 层. **10 mm**

40x120 (16"x48") 20mm R11 - 40x80 (16"x31 1/2") 20mm R11

Spessore. Thickness. Epaisseur. Stärke. Espesor. Толщина. 层. **20 mm**

Naturale e rettificato. Natural and rectified. Naturel et rectifié. Natur Oberfläche und kalibriert.
Natural y rectificado. Натуральный ректифицированный. 天然改制.

Esterno come estensione della casa.
Un legno che alla luce naturale riscopre le
sue antiche radici e incontra la poliedricità
del gres porcellanato.

Outdoors as an extension of the home.
A wood that reveals its ancient roots in natural light, while offering all the versatility of porcelain stoneware.

Extérieur comme l'extension de la maison. Un bois qui, à la lumière naturelle, redécouvre ses anciennes racines et rencontre le caractère polyédrique du grès cérame.

Außen als Erweiterung der Wohnung. Ein Holz, das im natürlichen Licht seine antiken Wurzeln wieder entdeckt und der Vielseitigkeit des Feinsteinzeugs begegnet.

Los exteriores como extensión de la casa.
Una madera que a la luz natural redescubre sus antiguas raíces y encuentra la poliedricidad del gres porcelánico.

Наружные пространства служат продолжением домашних.
При натуральном свете этот материал под дерево открывает свои старинные корни в сочетании с многогранностью керамогранита.

外面是家的延伸。自然光下该木材呈现其古老的纹理，与陶瓷产品交相辉映。



Civilization of Beauty

TABACCO 20x120 (8"x48") Nat. Ret. 10mm R11 outdoor



MORO 40x120 (16"x48") Nat. Ret. 20mm R11 outdoor



CANAPA 40x80 (16"x31 1/2") Nat. Ret. 20mm R11 *outdoor*

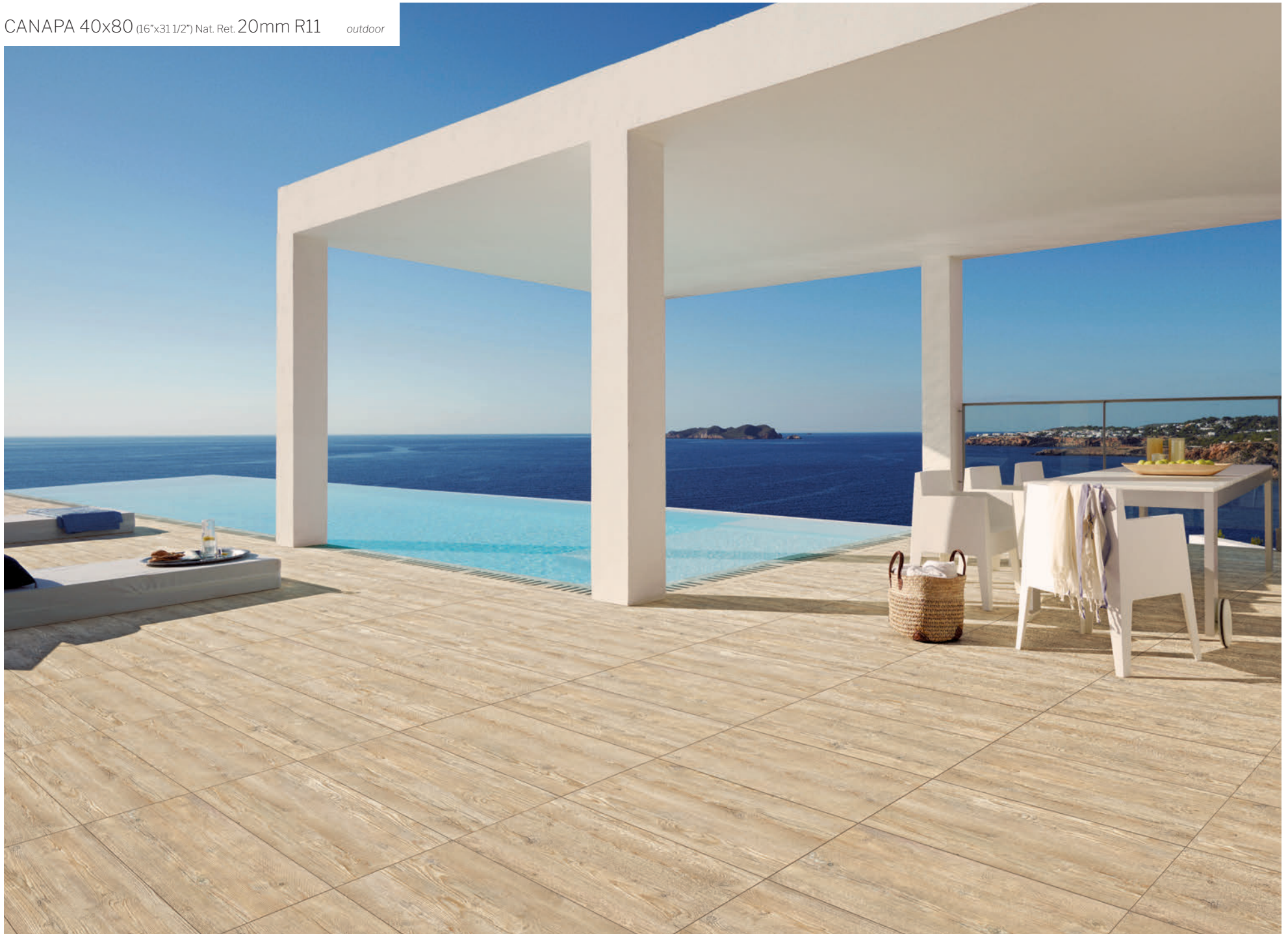

CA' FOSCARI

Antiche radici, spirito contemporaneo. *Ancient roots, contemporary spirit*

Gres porcellanato colorato in massa . Full-body coloured porcelain stoneware

Grès cérame coloré dans la masse . In der Masse gefärbtes Feinsteinzeug

Gres porcelánico coloreado en masa . Окрашенный по всей толщине керамогранит . 多彩陶瓷

Spessore. Thickness. Epaisseur. Stärke. Espesor. Толщина. 层. **10 mm**

Naturale e rettificato. Natural and rectified. Naturel et rectifié. Natur Oberfläche und kalibriert. Natural y rectificado. Натуральный ректифицированный. 天然改制.

LINO



B205 094001 Lino
20x120 . 8" x48" Nat. Ret.

B205 094002 Lino
20x120 . 8" x48" Nat. Ret. R11

CANAPA



B205 094005 Canapa
20x120 . 8" x48" Nat. Ret.

B205 094006 Canapa
20x120 . 8" x48" Nat. Ret. R11

AVANA



B205 094009 Avana
20x120 . 8" x48" Nat. Ret.

B205 094010 Avana
20x120 . 8" x48" Nat. Ret. R11

TABACCO



B205 094013 Tabacco
20x120 . 8" x48" Nat. Ret.

B205 094014 Tabacco
20x120 . 8" x48" Nat. Ret. R11

MORO



B205 094017 Moro
20x120 . 8" x48" Nat. Ret.

B205 094018 Moro
20x120 . 8" x48" Nat. Ret. R11

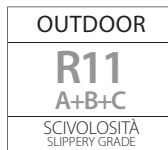
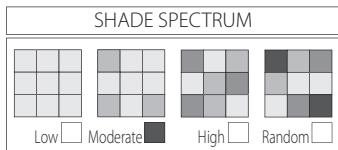

indoor - outdoor R11

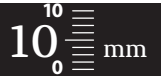

PEZZI SPECIALI Trims . Pièces spéciales . Formstücke . Piezas especiales
Специальные элементы . 特殊块



BATTISCOPIA
6,5x120 . 2 1/2"x48"
Nat. Ret.

- V220 094090** Lino
- V220 094091** Canapa
- V220 094092** Avana
- V220 094093** Tabacco
- V220 094094** Moro

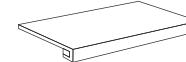

**** GRADINO COSTA RETTA**
33x120x3,2h . 13"x48"x1 1/4"h
Nat. Ret.

- V410 094060** Lino
- V410 094061** Canapa
- V410 094062** Avana
- V410 094063** Tabacco
- V410 094064** Moro



**** GRADINO COSTA RETTA ANGOLO SX**
33x120x3,2h . 13"x48"x1 1/4"h
Nat. Ret.

- V428 094080** Lino
- V428 094081** Canapa
- V428 094082** Avana
- V428 094083** Tabacco
- V428 094084** Moro



**** GRADINO COSTA RETTA ANGOLO DX**
33x120x3,2h . 13"x48"x1 1/4"h
Nat. Ret.

- V428 094070** Lino
- V428 094071** Canapa
- V428 094072** Avana
- V428 094073** Tabacco
- V428 094074** Moro

**** A disposizione solo su richiesta. Tempi di consegna: 30gg.**

Available upon request only. Delivery terms: 30 days. Disponible seulement sur requête. Délais de livraison: 30 jours. Verfügbar auf Anfrage. Lieferzeit: 30 Tage.
Disponibile sólo bajo pedido. Plazo de entrega: 30 días. Изготавливается только по специальной заявке. Срок поставки: 30 дней. 仅按需供给。交付时间: 30日

Per il gradino non si garantisce la stessa tonalità del fondo.

We cannot guarantee that the shade of the stair tile will be the same as the background tile. Pour la marche, nous ne garantissons pas la même tonalité du fond.
Für die Stufe wird nicht der gleiche Farbton des Untergrunds garantiert. Para el peldaño no se garantiza el mismo tono del fondo.
Для ступени не гарантирована одинаковость тона с фоном. 对于台阶不保证底色一致

ATTENZIONE Attention . Attention . Warnung . Atención . Внимание . 注意

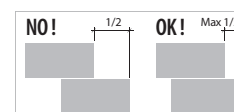

Si consiglia di mantenere una fuga di 2 mm per la posa in monofornato degli articoli rettificati.

If you are laying same sized straightened-edged tiles, we recommend you keep a 2 mm joint. On conseil de préserver un joint de 2 mm pour la pose en mon format des articles rectifiés. Es wird geraten, eine Fuge von 2 mm bei der Verlegung der geschliffenen Artikel im Einzelformat einzuhalten. Se aconseja mantener una junta de 2 mm para la colocación en monofornato de los artículos rectificados. Рекомендуем оставлять межплиточный шов 2 мм при укладке обрезных изделий только одного формата.

Per un risultato ottimale si consiglia di utilizzare durante la posa i cunei.

For a perfect result, we recommend you use wedges during laying. Nous conseillons d'utiliser les coins durant la pose pour un résultat optimal. Für ein ausgezeichnetes Ergebnis wird empfohlen, bei der Verlegung die Keile zu verwenden. Para obtener un resultado optimizado se aconseja utilizar las cuñas durante la colocación. Для получения оптимального результата рекомендуется использовать клинья во время укладки. 为获得最佳结果, 建议安装期间使用工具。

CA' FOSCARI

Antiche radici, spirito contemporaneo. *Ancient roots, contemporary spirit*

Gres porcellanato colorato in massa . Full-body coloured porcelain stoneware

Grès cérame coloré dans la masse . In der Masse gefärbtes Feinsteinzeug

Gres porcelánico coloreado en masa . Окрашенный по всей толщине керамогранит . 多彩陶瓷

Spessore. Thickness. Epaisseur. Stärke. Espesor. Толщина. 层. **20 mm**

Naturale e rettificato. Natural and rectified. Naturel et rectifié. Natur Oberfläche und kalibriert. Natural y rectificado. Натуральный ректифицированный. 天然改制.

LINO



B259 094031 Lino
40x120 . 16"x48"
Nat. Ret. R11

CANAPA



B259 094032 Canapa
40x120 . 16"x48"
Nat. Ret. R11

AVANA



B259 094033 Avana
40x120 . 16"x48"
Nat. Ret. R11

TABACCO



B259 094034 Tabacco
40x120 . 16"x48"
Nat. Ret. R11

MORO



B259 094035 Moro
40x120 . 16"x48"
Nat. Ret. R11

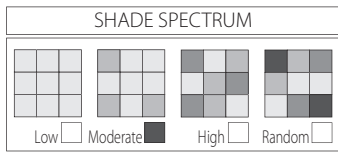

ANSI A
137.1: 2012

WET DYNAMIC
COEFFICIENT OF FRICTION

DCOF ≥ 0,42

OUTDOOR

R11
A+B+C

SCIVOLOSITÀ
SLIPPERY GRADE

outdoor R11

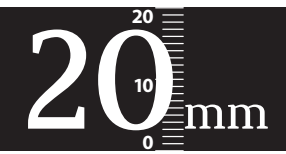

LINO



B258 094041 Lino
40x80 . 16"x31 1/2"
Nat. Ret. R11

CANAPA



B258 094042 Canapa
40x80 . 16"x31 1/2"
Nat. Ret. R11

AVANA



B258 094043 Avana
40x80 . 16"x31 1/2"
Nat. Ret. R11

TABACCO



B258 094044 Tabacco
40x80 . 16"x31 1/2"
Nat. Ret. R11

MORO



B258 094045 Moro
40x80 . 16"x31 1/2"
Nat. Ret. R11

CA' FOSCARI

Antiche radici, spirito contemporaneo. *Ancient roots, contemporary spirit*

Gres porcellanato colorato in massa . Full-body coloured porcelain stoneware

Grès cérame coloré dans la masse . In der Masse gefärbtes Feinsteinzeug

Gres porcelánico coloreado en masa . Окрашенный по всей толщине керамогранит . 多彩陶瓷

Spessore. Thickness. Epaisseur. Stärke. Espesor. Толщина. 层. 20 mm

□ **Naturale e rettificato.** Natural and rectified. Naturel et rectifié. Natur Oberfläche und kalibriert. Natural y rectificado. Натуральный ректифицированный. 天然改制.

PEZZI SPECIALI 20mm R11

Trims . Pièces spéciales . Formstücke . Piezas especiales . Специальные элементы . 特殊块

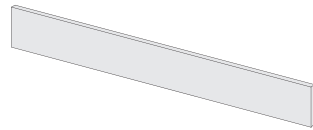

ALZATA **V325**

20x120 . 8"x48" Nat. Ret. □

094201 Lino
094202 Canapa
094203 Avana
094204 Tabacco
094205 Moro

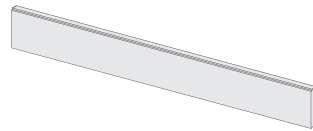

ALZATA CON SCURETTO **V380**

20x120 . 8"x48" Nat. Ret. □

094208 Lino
094209 Canapa
094210 Avana
094211 Tabacco
094212 Moro

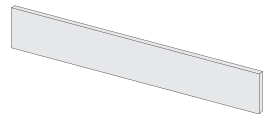

ALZATA **V260**

20x80 . 8"x31 1/2" Nat. Ret. □

094501 Lino
094502 Canapa
094503 Avana
094504 Tabacco
094505 Moro

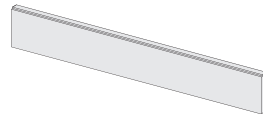

ALZATA CON SCURETTO **V337**

20x80 . 8"x31 1/2" Nat. Ret. □

094508 Lino
094509 Canapa
094510 Avana
094511 Tabacco
094512 Moro

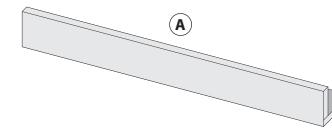
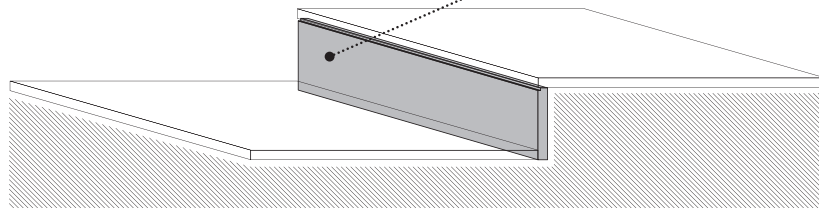
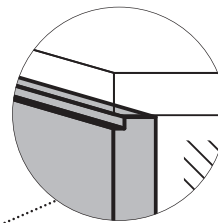

A BORDO L "A" **V397**

10x120x10h . 4"x48"x4"h Nat. Ret. □

094215 Lino
094216 Canapa
094217 Avana
094218 Tabacco
094219 Moro

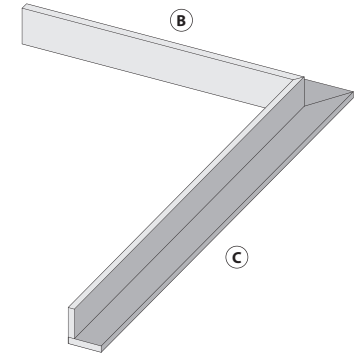

B BORDO L "A" - DX **V415**

10x120x10h . 4"x48"x4"h Nat. Ret. □

094221 Lino
094222 Canapa
094223 Avana
094224 Tabacco
094225 Moro

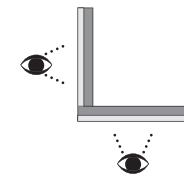

C BORDO L "A" - SX **V415**

10x120x10h . 4"x48"x4"h Nat. Ret. □

094228 Lino
094229 Canapa
094230 Avana
094231 Tabacco
094232 Moro

SHADE SPECTRUM			
Low <input type="checkbox"/>	Moderate <input checked="" type="checkbox"/>	High <input type="checkbox"/>	Random <input type="checkbox"/>

ANSI A 137.1: 2012
WET DYNAMIC COEFFICIENT OF FRICTION
DCOF ≥ 0,42

OUTDOOR
R11
A+B+C
SCIVOLOSITÀ SLIPPERY GRADE

outdoor R11

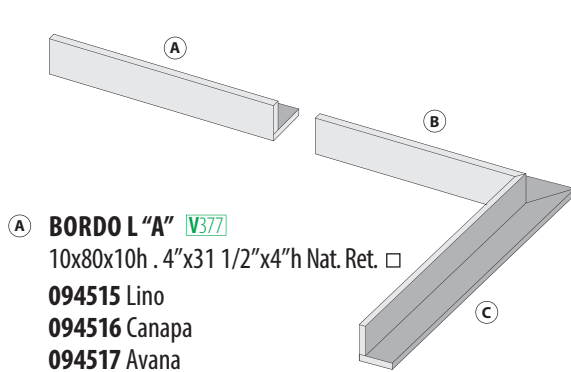

- A BORDO L "A" V377**
10x80x10h . 4"x31 1/2"x4"h Nat. Ret.
094515 Lino
094516 Canapa
094517 Avana
094518 Tabacco
094519 Moro

- B BORDO L "A" - DX V392**
10x80x10h . 4"x31 1/2"x4"h Nat. Ret.
094522 Lino
094523 Canapa
094524 Avana
094525 Tabacco
094526 Moro

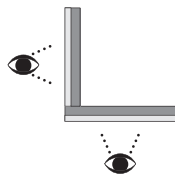

- C BORDO L "A" - SX V392**
10x80x10h . 4"x31 1/2"x4"h Nat. Ret.
094528 Lino
094529 Canapa
094530 Avana
094531 Tabacco
094532 Moro

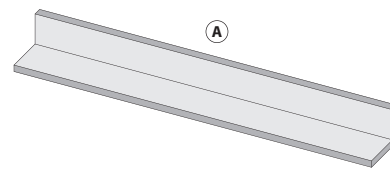

- A BORDO L "B" V438**
10x120x10h . 4"x48"x4"h Nat. Ret.
094235 Lino
094236 Canapa
094237 Avana
094238 Tabacco
094239 Moro

- B BORDO L "B" - DX V462**
10x120x10h . 4"x48"x4"h Nat. Ret.
094242 Lino
094243 Canapa
094244 Avana
094245 Tabacco
094246 Moro



- C BORDO L "B" - SX V462**
10x120x10h . 4"x48"x4"h Nat. Ret.
094249 Lino
094250 Canapa
094251 Avana
094252 Tabacco
094253 Moro

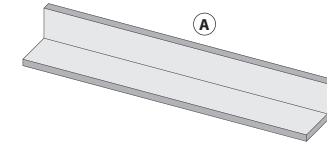
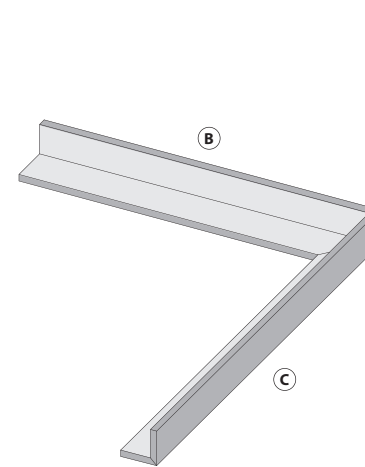

- A BORDO L "B" V397**
10x80x10h . 4"x31 1/2"x4"h Nat. Ret.
094535 Lino
094536 Canapa
094537 Avana
094538 Tabacco
094539 Moro

- B BORDO L "B" - DX V415**
10x80x10h . 4"x31 1/2"x4"h Nat. Ret.
094542 Lino
094543 Canapa
094544 Avana
094545 Tabacco
094546 Moro



- C BORDO L "B" - SX V415**
10x80x10h . 4"x31 1/2"x4"h Nat. Ret.
094549 Lino
094550 Canapa
094551 Avana
094552 Tabacco
094553 Moro

CA' FOSCARI

Antiche radici, spirito contemporaneo. *Ancient roots, contemporary spirit*

Gres porcellanato colorato in massa . Full-body coloured porcelain stoneware

Grès cérame coloré dans la masse . In der Masse gefärbtes Feinsteinzeug

Gres porcelánico coloreado en masa . Окрашенный по всей толщине керамогранит . 多彩陶瓷

Spessore. Thickness. Epaisseur. Stärke. Espesor. Толщина. 层. **20 mm**

□ **Naturale e rettificato.** Natural and rectified. Naturel et rectifié. Natur Oberfläche und kalibriert. Natural y rectificado. Натуральный ректифицированный. 天然改制.

PEZZI SPECIALI 20mm R11

Trims . Pièces spéciales . Formstücke . Piezas especiales . Специальные элементы . 特殊块

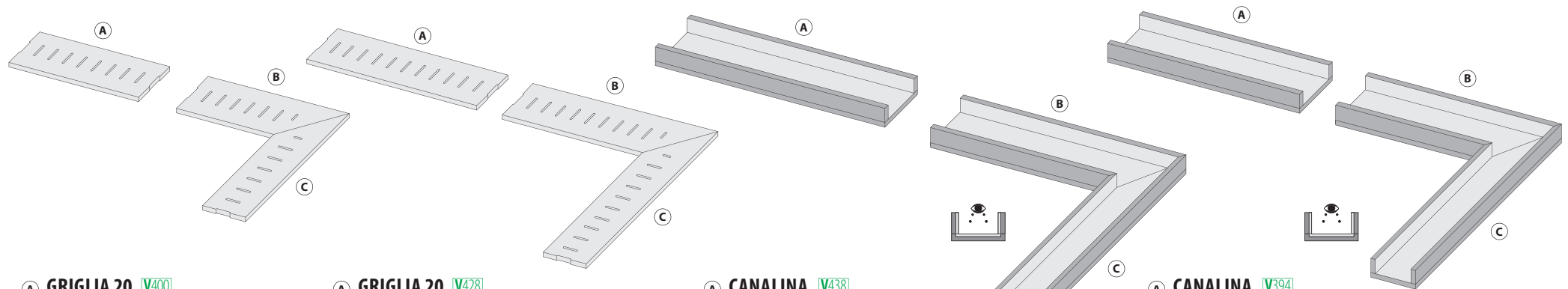

A **GRIGLIA 20** V400
20x60 . 8"x24" Nat. Ret. □
094256 Lino
094257 Canapa
094258 Avana
094259 Tabacco
094260 Moro

A **GRIGLIA 20** V428
20x80 . 8"x31 1/2" Nat. Ret. □
094556 Lino
094557 Canapa
094558 Avana
094559 Tabacco
094560 Moro

A **CANALINA** V438
20x120x8h . 8"x48"x3"h Nat. Ret. □
094277 Lino
094278 Canapa
094279 Avana
094280 Tabacco
094281 Moro

A **CANALINA** V394
20x80x8h . 8"x31 1/2"x3"h Nat. Ret. □
094577 Lino
094578 Canapa
094579 Avana
094580 Tabacco
094581 Moro

B **GRIGLIA 20 - DX** V400
20x60 . 8"x24" Nat. Ret. □
094263 Lino
094264 Canapa
094265 Avana
094266 Tabacco
094267 Moro

B **GRIGLIA 20 - DX** V428
20x80 . 8"x31 1/2" Nat. Ret. □
094563 Lino
094564 Canapa
094565 Avana
094566 Tabacco
094567 Moro

B **CANALINA - DX** V450
20x120x8h . 8"x48"x3"h Nat. Ret. □
094284 Lino
094285 Canapa
094286 Avana
094287 Tabacco
094288 Moro

B **CANALINA - DX** V410
20x80x8h . 8"x31 1/2"x3"h Nat. Ret. □
094584 Lino
094585 Canapa
094586 Avana
094587 Tabacco
094588 Moro

C **GRIGLIA 20 - SX** V400
20x60 . 8"x24" Nat. Ret. □
094270 Lino
094271 Canapa
094272 Avana
094273 Tabacco
094274 Moro

C **GRIGLIA 20 - SX** V428
20x80 . 8"x31 1/2" Nat. Ret. □
094570 Lino
094571 Canapa
094572 Avana
094573 Tabacco
094574 Moro

C **CANALINA - SX** V450
20x120x8h . 8"x48"x3"h Nat. Ret. □
0947292 Lino
0947293 Canapa
0947294 Avana
0947295 Tabacco
0947296 Moro

C **CANALINA - SX** V410
20x80x8h . 8"x31 1/2"x3"h Nat. Ret. □
094592 Lino
094593 Canapa
094594 Avana
094595 Tabacco
094596 Moro

SHADE SPECTRUM			
Low <input type="checkbox"/>	Moderate <input type="checkbox"/>	High <input type="checkbox"/>	Random <input type="checkbox"/>

ANSI A 137.1: 2012
WET DYNAMIC COEFFICIENT OF FRICTION
DCOF ≥ 0,42

OUTDOOR
R11
A+B+C
SCIVOLITÀ SLIPPERY GRADE

outdoor R11

20 mm

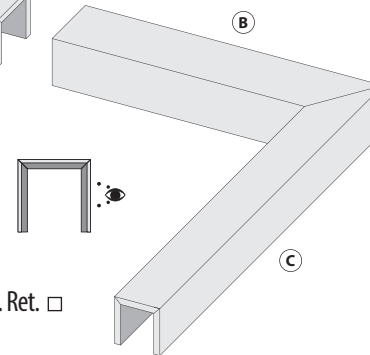
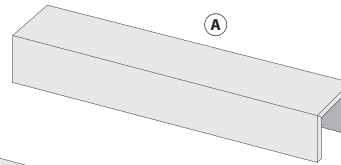
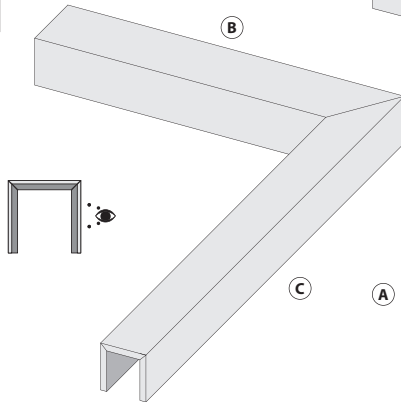
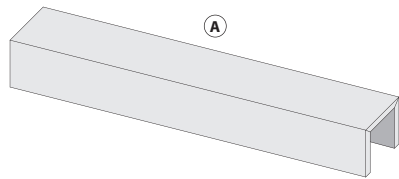

- A** **CORDOLO** **V480**
13x120x13h . 5"x48"x5"h Nat. Ret.
094299 Lino
094300 Canapa
094301 Avana
094302 Tabacco
094303 Moro

- B** **CORDOLO - DX** **V500**
13x120x13h . 5"x48"x5"h Nat. Ret.
094306 Lino
094307 Canapa
094308 Avana
094309 Tabacco
094310 Moro

- C** **CORDOLO - SX** **V500**
13x120x13h . 5"x48"x5"h Nat. Ret.
094313 Lino
094314 Canapa
094315 Avana
094316 Tabacco
094317 Moro

- A** **CORDOLO** **V415**
13x80x13h . 5"x31 1/2"x5"h Nat. Ret.
094599 Lino
094600 Canapa
094601 Avana
094602 Tabacco
094603 Moro

- B** **CORDOLO - DX** **V438**
13x80x13h . 5"x31 1/2"x5"h Nat. Ret.
094606 Lino
094607 Canapa
094608 Avana
094609 Tabacco
094610 Moro

- C** **CORDOLO - SX** **V438**
13x80x13h . 5"x31 1/2"x5"h Nat. Ret.
094613 Lino
094614 Canapa
094615 Avana
094616 Tabacco
094617 Moro



CA' FOSCARI

Antiche radici, spirito contemporaneo. *Ancient roots, contemporary spirit*

Gres porcellanato colorato in massa . Full-body coloured porcelain stoneware

Grès cérame coloré dans la masse . In der Masse gefärbtes Feinsteinzeug

Gres porcelánico coloreado en masa . Окрашенный по всей толщине керамогранит . 多彩陶瓷

Spessore. Thickness. Epaisseur. Stärke. Espesor. Толщина. 层. 20 mm

Naturale e rettificato. Natural and rectified. Naturel et rectifié. Natur Oberfläche und kalibriert.

Natural y rectificado. Натуральный ректифицированный. 天然改制.

PEZZI SPECIALI 20mm R11

Trims . Pièces spéciales . Formstücke . Piezas especiales . Специальные элементы . 特殊块

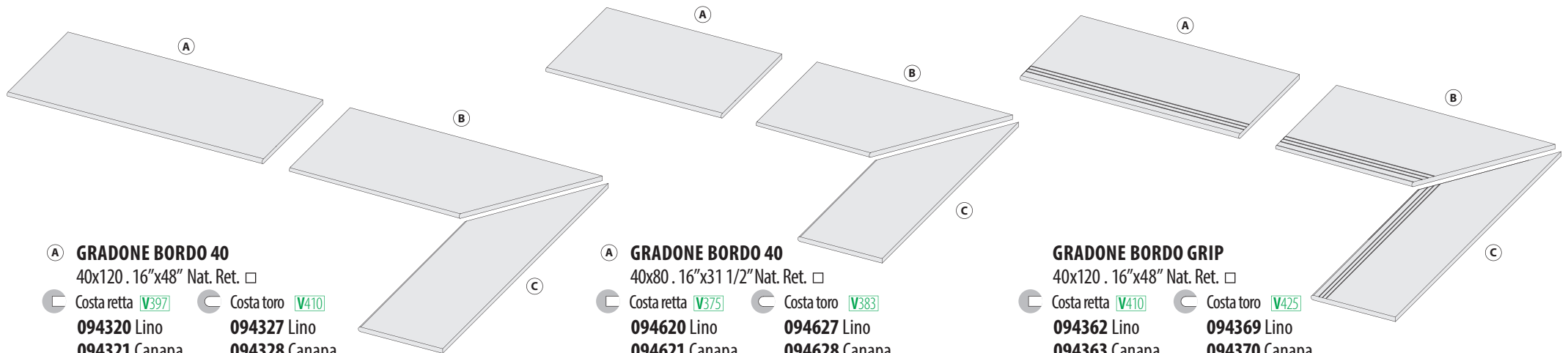

A GRADONE BORDO 40

40x120 . 16"x48" Nat. Ret.

- | | |
|---|--|
| <input type="checkbox"/> Costa retta V397 | <input type="checkbox"/> Costa toro V410 |
| 094320 Lino | 094327 Lino |
| 094321 Canapa | 094328 Canapa |
| 094322 Avana | 094329 Avana |
| 094323 Tabacco | 094330 Tabacco |
| 094324 Moro | 094331 Moro |

A GRADONE BORDO 40

40x80 . 16"x31 1/2" Nat. Ret.

- | | |
|---|--|
| <input type="checkbox"/> Costa retta V375 | <input type="checkbox"/> Costa toro V383 |
| 094620 Lino | 094627 Lino |
| 094621 Canapa | 094628 Canapa |
| 094622 Avana | 094629 Avana |
| 094623 Tabacco | 094630 Tabacco |
| 094624 Moro | 094631 Moro |

GRADONE BORDO GRIP

40x120 . 16"x48" Nat. Ret.

- | | |
|---|--|
| <input type="checkbox"/> Costa retta V410 | <input type="checkbox"/> Costa toro V425 |
| 094362 Lino | 094369 Lino |
| 094363 Canapa | 094370 Canapa |
| 094364 Avana | 094371 Avana |
| 094365 Tabacco | 094372 Tabacco |
| 094366 Moro | 094373 Moro |

B GRADONE BORDO 40 - DX

40x120 . 16"x48" Nat. Ret.

- | | |
|---|--|
| <input type="checkbox"/> Costa retta V410 | <input type="checkbox"/> Costa toro V420 |
| 094334 Lino | 094341 Lino |
| 094335 Canapa | 094342 Canapa |
| 094336 Avana | 094343 Avana |
| 094337 Tabacco | 094344 Tabacco |
| 094338 Moro | 094345 Moro |

B GRADONE BORDO 40 - DX

40x80 . 16"x31 1/2" Nat. Ret.

- | | |
|---|--|
| <input type="checkbox"/> Costa retta V385 | <input type="checkbox"/> Costa toro V392 |
| 094634 Lino | 094641 Lino |
| 094635 Canapa | 094642 Canapa |
| 094636 Avana | 094643 Avana |
| 094637 Tabacco | 094644 Tabacco |
| 094638 Moro | 094645 Moro |

B GRADONE BORDO GRIP - DX

40x120 . 16"x48" Nat. Ret.

- | | |
|---|--|
| <input type="checkbox"/> Costa retta V425 | <input type="checkbox"/> Costa toro V438 |
| 094376 Lino | 094383 Lino |
| 094377 Canapa | 094384 Canapa |
| 094378 Avana | 094385 Avana |
| 094379 Tabacco | 094386 Tabacco |
| 094380 Moro | 094387 Moro |

C GRADONE BORDO 40 - SX

40x120 . 16"x48" Nat. Ret.

- | | |
|---|--|
| <input type="checkbox"/> Costa retta V410 | <input type="checkbox"/> Costa toro V420 |
| 094348 Lino | 094355 Lino |
| 094349 Canapa | 094356 Canapa |
| 094350 Avana | 094357 Avana |
| 094351 Tabacco | 094358 Tabacco |
| 094352 Moro | 094359 Moro |

C GRADONE BORDO 40 - SX

40x80 . 16"x31 1/2" Nat. Ret.

- | | |
|---|--|
| <input type="checkbox"/> Costa retta V385 | <input type="checkbox"/> Costa toro V392 |
| 094648 Lino | 094655 Lino |
| 094649 Canapa | 094656 Canapa |
| 094650 Avana | 094657 Avana |
| 094651 Tabacco | 094658 Tabacco |
| 094652 Moro | 094659 Moro |

C GRADONE BORDO GRIP - SX

40x120 . 16"x48" Nat. Ret.

- | | |
|---|--|
| <input type="checkbox"/> Costa retta V425 | <input type="checkbox"/> Costa toro V438 |
| 094390 Lino | 094397 Lino |
| 094391 Canapa | 094398 Canapa |
| 094392 Avana | 094399 Avana |
| 094393 Tabacco | 094400 Tabacco |
| 094394 Moro | 094401 Moro |

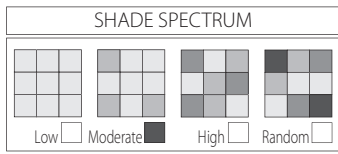

ANSI A
137.1: 2012
WET DYNAMIC
COEFFICIENT OF FRICTION
DCOF ≥ 0,42

OUTDOOR
R11
A+B+C
SCIVOLOSITÀ
SLIPPERY GRADE

20 mm

outdoor R11

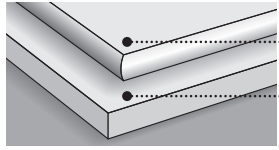

Costa toro . Bullnose edge . Bord boudin . Abgerundete Kante .

Costa retta . Straight edge . Bord droit . Gerade Kante .

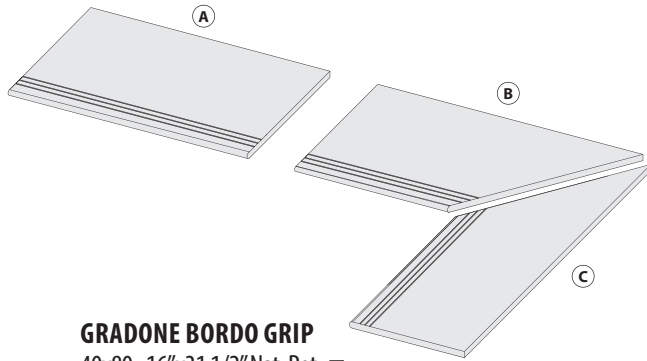

GRADONE BORDO GRIP

40x80 . 16"x31 1/2" Nat. Ret. □

- | | |
|--------------------------------|-------------------------------|
| Costa retta V385 | Costa toro V392 |
| 094662 Lino | 094669 Lino |
| 094663 Canapa | 094670 Canapa |
| 094664 Avana | 094671 Avana |
| 094665 Tabacco | 094672 Tabacco |
| 094666 Moro | 094673 Moro |

GRADONE BORDO SVASATO

40x120 . 16"x48" Nat. Ret. □

- | | |
|--------------------------------|-------------------------------|
| Costa retta V492 | Costa toro V522 |
| 094404 Lino | 094411 Lino |
| 094405 Canapa | 094412 Canapa |
| 094406 Avana | 094413 Avana |
| 094407 Tabacco | 094414 Tabacco |
| 094408 Moro | 094415 Moro |

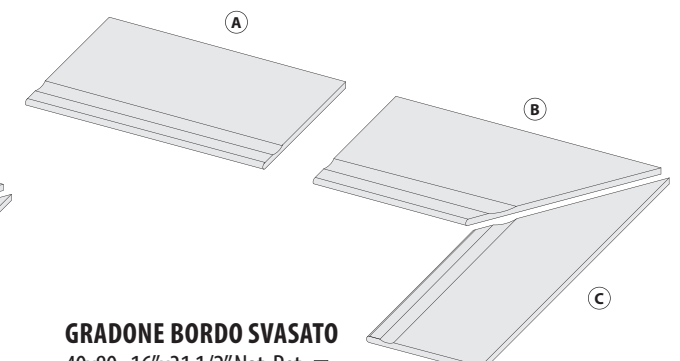

GRADONE BORDO SVASATO

40x80 . 16"x31 1/2" Nat. Ret. □

- | | |
|--------------------------------|-------------------------------|
| Costa retta V425 | Costa toro V438 |
| 094704 Lino | 094711 Lino |
| 094705 Canapa | 094712 Canapa |
| 094706 Avana | 094713 Avana |
| 094707 Tabacco | 094714 Tabacco |
| 094708 Moro | 094715 Moro |

GRADONE BORDO GRIP - DX

40x80 . 16"x31 1/2" Nat. Ret. □

- | | |
|--------------------------------|-------------------------------|
| Costa retta V392 | Costa toro V397 |
| 094676 Lino | 094683 Lino |
| 094677 Canapa | 094684 Canapa |
| 094678 Avana | 094685 Avana |
| 094679 Tabacco | 094686 Tabacco |
| 094680 Moro | 094687 Moro |

GRADONE BORDO SVASATO - DX

40x120 . 16"x48" Nat. Ret. □

- | | |
|--------------------------------|-------------------------------|
| Costa retta V500 | Costa toro V522 |
| 094418 Lino | 094425 Lino |
| 094419 Canapa | 094426 Canapa |
| 094420 Avana | 094427 Avana |
| 094421 Tabacco | 094428 Tabacco |
| 094422 Moro | 094429 Moro |

GRADONE BORDO SVASATO - DX

40x80 . 16"x31 1/2" Nat. Ret. □

- | | |
|--------------------------------|-------------------------------|
| Costa retta V438 | Costa toro V448 |
| 094718 Lino | 094725 Lino |
| 094719 Canapa | 094726 Canapa |
| 094720 Avana | 094727 Avana |
| 094721 Tabacco | 094728 Tabacco |
| 094722 Moro | 094729 Moro |

GRADONE BORDO GRIP - SX

40x80 . 16"x31 1/2" Nat. Ret. □

- | | |
|--------------------------------|-------------------------------|
| Costa retta V392 | Costa toro V397 |
| 094690 Lino | 094697 Lino |
| 094691 Canapa | 094698 Canapa |
| 094692 Avana | 094699 Avana |
| 094693 Tabacco | 094700 Tabacco |
| 094694 Moro | 094701 Moro |

GRADONE BORDO SVASATO - SX

40x120 . 16"x48" Nat. Ret. □

- | | |
|--------------------------------|-------------------------------|
| Costa retta V500 | Costa toro V522 |
| 094432 Lino | 094439 Lino |
| 094433 Canapa | 094440 Canapa |
| 094434 Avana | 094441 Avana |
| 094435 Tabacco | 094442 Tabacco |
| 094436 Moro | 094443 Moro |

GRADONE BORDO SVASATO - SX

40x80 . 16"x31 1/2" Nat. Ret. □

- | | |
|--------------------------------|-------------------------------|
| Costa retta V438 | Costa toro V448 |
| 094732 Lino | 094739 Lino |
| 094733 Canapa | 094740 Canapa |
| 094734 Avana | 094741 Avana |
| 094735 Tabacco | 094742 Tabacco |
| 094736 Moro | 094743 Moro |

CA' FOSCARI

Antiche radici, spirito contemporaneo. *Ancient roots, contemporary spirit*

IL SUPPORTO FISSO Fixed pedestals. Le plot fixe. Fixhalterung.



201011 Supporto Fisso 15 **V30** = 4 pcs



Ø 110 mm
201013 **V30** = 4 pcs
Spessore-livellatore in gomma: 3 mm - Rubber levelling shims: 3 mm
Cale-correcteur de pente en caoutchouc: 3 mm - Stärke des Nivellierers aus Gummi: 3 mm



Ø 110 mm
201012 **V30** = 4 pcs
Spessore-livellatore in gomma: 2 mm - Rubber levelling shims: 2 mm
Cale-correcteur de pente en caoutchouc: 2 mm - Stärke des Nivellierers aus Gummi: 2 mm

IL SUPPORTO REGOLABILE Adjustable pedestals. Le plot réglable. Regelbare Stütze.

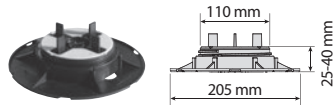

201006 **V110**
Supporto regolabile - Adjustable paving support
mm 25/40

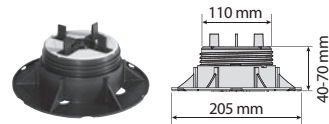

201007 **V130**
Supporto regolabile - Adjustable paving support
mm 40/70

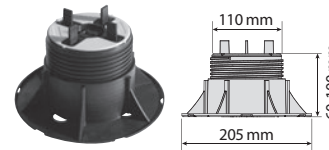

201008 **V134**
Supporto regolabile - Adjustable paving support
mm 60/100

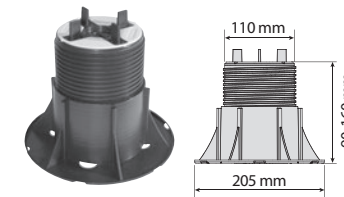

201009 **V143**
Supporto regolabile - Adjustable paving support
mm 90/160

IL SUPPORTO REGOLABILE AUTOLIVELLANTE Self-levelling adjustable pedestals. Le plot réglable auto-nivelant. Regelbare, selbstnivellierende Stütze.

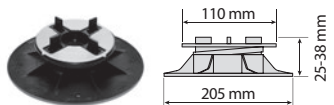

201001 **V134**
Supporto regolabile autolivellante
Adjustable paving support self leveling head
mm 28/38

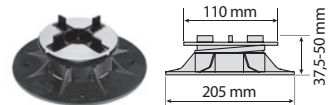

201002 **V143**
Supporto regolabile autolivellante
Adjustable paving support self leveling head
mm 37,5/50

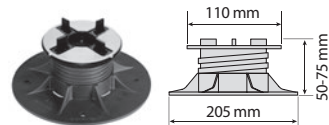

201003 **V145**
Supporto regolabile autolivellante
Adjustable paving support self leveling head
mm 50/75

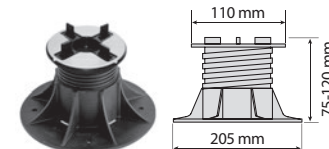

201004 **V150**
Supporto regolabile autolivellante
Adjustable paving support self leveling head
mm 75/120

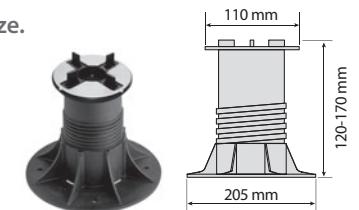

201005 **V160**
Supporto regolabile autolivellante
Adjustable paving support self leveling head
mm 120/170



201015 **V110**
Clip universale per bordo piastra
Universal edge clip



201014 **V383**
Chiave di regolazione
Adjustment key

IMBALLI Package . Emballage . Verpackung . Embalajes . Упаковка . 包装

DESCRIZIONE Description Description Beschreibung	PZ. X SCAT. Pieces x Box Stk. x Krt. Pcs / Bte	MQ. X SCAT. Sqm x Box Qm x Krt. M2/ Bte	KG X SCAT. Weight x Box Gewicht x Krt. (kg) Poids / Bte (kg)	EUROPALLET 80x120 cm			
				SCAT. X PAL. Boxes x Pal. Krt. x Pal. Bte / Pal.	MQ. X PAL. Sqm x Pal. Qm x Pal. M2 / Pal.	KG X PAL. Weight x Pal. Gewicht x Pal (kg) Poids / Pal. (kg)	Cm. h Pal.
SUPPORTO 15 FISSO							
Supporto 15 fisso	200	-	10,00	20	-	-	-
Livellatore in gomma 3 mm	500	-	12,00	70	-	-	-
Livellatore in gomma 2 mm	600	-	10,20	70	-	-	-
SUPPORTO REGOLABILE							
Supporto regolabile mm 25/40	30	-	6,39	42	-	-	-
Supporto regolabile mm 40/70	35	-	9,28	30	-	-	-
Supporto regolabile mm 60/100	25	-	8,63	30	-	-	-
Supporto regolabile mm 90/160	20	-	8,42	30	-	-	-
SUPPORTO REGOLABILE AUTOLIVELLANTE							
Supporto regolabile autolivellante 28/38	50	-	13,15	30	-	-	-
Supporto regolabile autolivellante 37,5/50	40	-	14,40	30	-	-	-
Supporto regolabile autolivellante 50/75	30	-	10,65	30	-	-	-
Supporto regolabile autolivellante 75/120	30	-	13,80	20	-	-	-
Supporto regolabile autolivellante 120/170	25	-	13,13	20	-	-	-
Chiave di regolazione	1	-	0,10	-	-	-	-
Clip universale per bordo piastra	-	-	-	-	-	-	-

ATTENZIONE: Per particolari installazioni potrebbero essere necessari articoli ed accessori specifici non presenti in questo catalogo. Per queste esigenze prego riferirsi direttamente al referente commerciale La Fabbrica.

N.B. Particular items and accessories not listed in this catalogue may be required for certain laying methods. For these needs, please contact the La Fabbrica sales directly.

ATTENTION : Pour les installations particulières, certains articles et accessoires particuliers qui ne sont pas indiqués dans ce catalogue pourraient être nécessaires. Dans ces cas-là, nous vous prions de vous référer directement à la référence commerciale La Fabbrica.

ACHTUNG: Für besondere Installationen können besondere Artikel oder Sonderzubehör notwendig sein, die nicht im vorliegenden Katalog aufgeführt sind. Wenden Sie sich bitte in diesen Fällen direkt an den Vertrieb von La Fabbrica.

40x80 - Consumo di supporti per m2: m2 pavimentazione x 2,8 + 10%

40x80 - Pedestals required per m2: Sqm flooring/paving x 2.8 + 10%

40x80 - Nombre de plots par m2: m2 de revêtement x 2,8 + 10%

40x80 - Verbrauch an Stützen pro m2: m2 Boden x 2,8 + 10 %

40x120 - Consumo di supporti per m2: m2 pavimentazione x 3 + 10%

40x120 - Pedestals required per m2: Sqm flooring/paving x 3 + 10%

40x120 - Nombre de plots par m2: m2 de revêtement x 3 + 10%

40x120 - Verbrauch an Stützen pro m2: m2 Boden x 3 + 10 %

CERTIFICAZIONI DI PRODOTTO Product certification . Certification de produit . Produkt Zertifizierungen . Certificaciones de producto . Сертификация . 产品认证



放射性水平 A 类

Certificazione obbligatoria per l'esportazione in Cina
Certification mandatory for export to China
Certification obligatoire pour l'exportation en Chine
Für den Export nach China obligatorische Zertifizierung
Certificación obligatoria para la exportación a China
Обязательная сертификация для экспорта в Китай



100% DESIGN
AND PRODUCTION
OF ITALY



								PALLET 82x120 cm	
FORMATO Size Format Format	PZ. X SCAT. Pieces x Box Stk. x Krt. Pcs / Bte	MQ. X SCAT. Sqm x Box Qm x Krt. M2/ Bte	KG X SCAT. Weight x Box Gewicht x Krt. (kg) Poids / Bte (kg)	SCAT. X PAL. Boxes x Pal. Krt. x Pal. Bte / Pal.	MQ. X PAL. Sqm x Pal. Qm x Pal. M2 / Pal.	KG X PAL. Weight x Pal. Gewicht x Pal (kg) Poids / Pal. (kg)	Cm. h Pal.		
NATURALE E RETTIFICATO / NATURALE E RETTIFICATO R11									
20x120	4	0,96	21,90	48	46,08	1.066	70		
								EUROPALLET 80x120 cm	
NATURALE E RETTIFICATO									
Battiscopa 6,5x120	6	-	11,40	-	-	-	-		
Gradino costa retta 33x120x3,2h	2	-	22,00	-	-	-	-		
Gradino costa retta angolo DX 33x120x3,2h	1	-	12,00	-	-	-	-		
Gradino costa retta angolo SX 33x120x3,2h	1	-	12,00	-	-	-	-		
NATURALE RETTIFICATO 20 mm R11									
40x120	2	0,96	43,01	24	23,04	1.052	75		
PEZZI SPECIALI 20 mm R11 Trims. Pièces spéciales. Formstücke.									
Gradone Bordo 40x120 - Costa retta / Costa toro	1	-	21,50	-	-	-	-		
Gradone Bordo ang DX 40x120 - Costa retta / Costa toro	1	-	21,50	-	-	-	-		
Gradone Bordo ang SX 40x120 - Costa retta / Costa toro	1	-	21,50	-	-	-	-		
Gradone Bordo Grip 40x120 - Costa retta / Costa toro	1	-	21,50	-	-	-	-		
Gradone Bordo Grip ang DX 40x120 - Costa retta / Costa toro	1	-	21,50	-	-	-	-		
Gradone Bordo Grip ang SX 40x120 - Costa retta / Costa toro	1	-	21,50	-	-	-	-		
Gradone Bordo Svasato 40x120 - Costa retta / Costa toro	1	-	21,50	-	-	-	-		
Gradone Bordo Svasato ang DX 40x120 - Costa retta / Costa toro	1	-	21,50	-	-	-	-		
Gradone Bordo Svasato ang SX 40x120 - Costa retta / Costa toro	1	-	21,50	-	-	-	-		
Griglia 20 - 20x60	1	-	6,00	-	-	-	-		
Griglia 20 - 20x60 DX	1	-	5,50	-	-	-	-		
Griglia 20 - 20x60 SX	1	-	5,50	-	-	-	-		
Canalina 20x120x8h	1	-	18,00	-	-	-	-		
Canalina 20x120x8h DX	1	-	19,00	-	-	-	-		
Canalina 20x120x8h SX	1	-	19,00	-	-	-	-		
Cordolo 13x120x13h	1	-	18,00	-	-	-	-		
Cordolo 13x120x13h DX	1	-	19,00	-	-	-	-		
Cordolo 13x120x13h SX	1	-	19,00	-	-	-	-		
Bordo L "A" 10x120x10h	1	-	16,00	-	-	-	-		
Bordo L "A" 10x120x10h DX	1	-	17,00	-	-	-	-		
Bordo L "A" 10x120x10h SX	1	-	17,00	-	-	-	-		
Bordo L "B" 10x120x10h	1	-	16,00	-	-	-	-		
Bordo L "B" 10x120x10h DX	1	-	17,00	-	-	-	-		
Bordo L "B" 10x120x10h SX	1	-	17,00	-	-	-	-		
Alzata 20x120	1	-	8,00	-	-	-	-		
Alzata con scuretto 20x120	1	-	8,00	-	-	-	-		















FORMATO Size Format Format	PZ. X SCAT. Pieces x Box Stk. x Krt. Pcs / Bte	MQ. X SCAT. Sqm x Box Qm x Krt. M2/ Bte	KG X SCAT. Weight x Box Gewicht x Krt. (kg) Poids / Bte (kg)	EUROPALLET 80x120 cm			
				SCAT. X PAL. Boxes x Pal. Krt. x Pal. Bte / Pal.	MQ. X PAL. Sqm x Pal. Qm x Pal. M2 / Pal.	KG X PAL. Weight x Pal. Gewicht x Pal (kg) Poids / Pal. (kg)	Cm. h Pal.
NATURALE RETTIFICATO 20 mm R11							
40x80	2	0,64	28,70	48	30,72	1.398	95
PEZZI SPECIALI 20 mm R11 Trims. Pièces spéciales. Formstücke.							
Gradone Bordo 40x80 - Costa retta / Costa toro	1	-	12,50	-	-	-	-
Gradone Bordo ang DX 40x80 - Costa retta / Costa toro	1	-	12,50	-	-	-	-
Gradone Bordo ang SX 40x80 - Costa retta / Costa toro	1	-	12,50	-	-	-	-
Gradone Bordo Grip 40x80 - Costa retta / Costa toro	1	-	12,50	-	-	-	-
Gradone Bordo Grip ang DX 40x80 - Costa retta / Costa toro	1	-	12,50	-	-	-	-
Gradone Bordo Grip ang SX 40x80 - Costa retta / Costa toro	1	-	12,50	-	-	-	-
Gradone Bordo Svasato 40x80 - Costa retta / Costa toro	1	-	12,50	-	-	-	-
Gradone Bordo Svasato ang DX 40x80 - Costa retta / Costa toro	1	-	12,50	-	-	-	-
Gradone Bordo Svasato ang SX 40x80 - Costa retta / Costa toro	1	-	12,50	-	-	-	-
Griglia 20 - 20x80	1	-	8,00	-	-	-	-
Griglia 20 - 20x80 DX	1	-	7,50	-	-	-	-
Griglia 20 - 20x80 SX	1	-	7,50	-	-	-	-
Canalina 20x80x8h	1	-	12,00	-	-	-	-
Canalina 20x80x8h DX	1	-	13,00	-	-	-	-
Canalina 20x80x8h SX	1	-	13,00	-	-	-	-
Cordolo 13x80x13h	1	-	12,00	-	-	-	-
Cordolo 13x80x13h DX	1	-	13,00	-	-	-	-
Cordolo 13x80x13h SX	1	-	13,00	-	-	-	-
Bordo L "A" 10x80x10h	1	-	11,00	-	-	-	-
Bordo L "A" 10x80x10h DX	1	-	12,00	-	-	-	-
Bordo L "A" 10x80x10h SX	1	-	12,00	-	-	-	-
Bordo L "B" 10x80x10h	1	-	8,00	-	-	-	-
Bordo L "B" 10x80x10h DX	1	-	9,00	-	-	-	-
Bordo L "B" 10x80x10h SX	1	-	9,00	-	-	-	-
Alzata 20x80	1	-	6,00	-	-	-	-
Alzata con scuretto 20x80	1	-	6,00	-	-	-	-

I pesi riportati in tabella sono indicativi in quanto possono subire leggere variazioni per motivi produttivi. The weights stated in the chart are approximate as some changes may be necessary for production reasons. Les poids figurant dans le tableau sont fournis à titre indicatif car ils peuvent subir de légères variations pour des raisons de production. Die in der Tabelle aufgeführten Gewichte sind nicht bindend, da sie aus Produktionsgründen leichte Änderungen aufweisen können. Los pesos señalados en la tabla son aproximados ya que pueden experimentar ligeras variaciones por motivos productivos. Указанный в таблице вес является приблизительным, так как ввиду производственных потребностей, он может слегка измениться. 表格记载的重量只具有提示意义，因为可能在生产过程中产生轻微的偏差。

Il peso dei PEZZI SPECIALI 20 mm indicato in tabella si riferisce al peso del singolo pezzo. Per calcolare il peso complessivo del materiale imballato occorrerà aggiungere al peso in tabella il peso dell'imballo e della paletta (peso variabile da 10 a 30 kg in funzione della quantità e della tipologia dei PEZZI SPECIALI richiesti). The weight of the 20 mm TRIMS stated in the table refers to the weight of each trim. To calculate the total weight of the packed material, you will need to add the combined weight of the packing materials and the pallet (weight ranging from 10 to 30kg depending on the quantity and the type of the trims required) to the weight stated in the table. Le poids des PIÈCES SPÉCIALES 20 mm indiqué dans le tableau se réfère au poids individuel de chaque pièce. Pour calculer le poids total du matériel emballé, il faudra ajouter au poids indiqué dans le tableau le poids de l'emballage et de la palette (poids variable de 10 à 30 kg en fonction de la quantité et du type de PIÈCES SPÉCIALES demandées). Das in der Tabelle angegebene Gewicht der 20 mm-SONDERTEILE bezieht sich auf das Gewicht des Einzelteils. Zur Berechnung des Gesamtgewichts des verpackten Materials muss zum in der Tabelle aufgeführten Wert das Gewicht der Verpackung und der Palette (von 10 bis 30 kg variierbar in Abhängigkeit von der Menge und Art der gewünschten SONDERTEILE) dazugerechnet werden.

CARATTERISTICHE TECNICHE Technical features . Caracteristiques techniques . Technische Eigenschaften . Características técnicas . Технические характеристики . 技术特征

GRES PORCELLANATO COLORATO IN MASSA ISO 13006 - G - BIA (E ≤ 0,5%) UNI EN 14411 - G - FULL-BODY COLOURED PORCELAIN STONEWARE . GRES CERAME COLORE DANS LA MASSE. IN DER MASSE GEFÄRBTES FEINSTEINZEUG. GRES PORCELÁNICO COLOREADO EN MASA. ОКРАШЕННЫЙ ПО ВСЕЙ ТОЛЩИНЕ КЕРАМОГРАНИТ - ISO 13006 - G - Bia (E ≤ 0,5%) UNI EN 14411 - G -

	CARATTERISTICA SPECIFICATION CARACTERISTIQUE EIGENSCHAFT CARACTERÍSTICA СПЕЦИФИКА	METODO DI PROVA TEST METHODS METHODE D'ESSAI TESTVERFAHREN PRUEBA СТАНДАРТ ИСПЫТАНИЙ	VALORE PRESCRITTO GRES PORCELLANATO COLORATO IN MASSA FIXED VALUE VALEUR PRESCRITE VORGESCHRIEBENER WERT VALOR PRESCRITO ТРЕБОВАНИЕ	 Civilization of Beauty		
	CARATTERISTICHE DIMENSIONALI - DIMENSIONAL CHARACTERISTICS - DIMENSIONS - DIMENSIONALE EIGENSCHAFTEN - CARACTERÍSTICAS DIMENSIONALES - ПРОСТРАНСТВЕННЫЕ ХАРАКТЕРИСТИКИ	ISO 10545-2		NATURALE	RETTIFICATO	LAPPATO / RETTIFICATO
	LUNGHEZZA E LARGHEZZA - LENGTH AND WIDTH - LONGUER ET LARGEUR - LÄNGE UND BREITE - LARGURA Y LARQUEZA - ДЛИНА И ШИРИНА		± 0,5 %	± 0,3 %	± 0,2 %	± 0,2 %
	SPESORE - THICKNESS - EPAISSEUR - STÄRKE - ESPESOR - ТОЛЩИНА		± 5 %	± 4 %	± 4 %	± 4 %
	RETTILINEITÀ DEGLI SPIGOLI - STRAIGHTNESS OF EDGES - RECTITUDE DES BORDS - RECHTECKIGKEIT DER ECKEN - ORTOGONALIDAD DE LAS ESQUINAS - ПРЯМОЛИНЕЙНОСТЬ ГРАНИ		± 0,5 %	± 0,3 %	± 0,2 %	± 0,2 %
	ORTOGONALITÀ - ORTHOGONALITY - ORTHOGONALITE - RECHT WINKLIGKEIT - ORTOGONALIDAD - ПРЯМОУГОЛЬНОСТЬ		± 0,6 %	± 0,3 %	± 0,2 %	± 0,2 %
PLANARITÀ - PLANARITY - PLANARITE - EBENHEIT - PLANEIDAD - ЛИНЕЙНОСТЬ	± 0,5 %	± 0,3 %	± 0,3 %	± 0,2 %	± 0,2 %	
	ASSORBIMENTO D'ACQUA - WATER ABSORPTION - ABSORPTION D'EAU - WASSERAUFNAHME - ABSORCIÓN DE AGUA - ВОДОПОГЛАЩЕНИЕ	ISO 10545-3	≤ 0,5 %	≤ 0,02 %		
	RESISTENZA ALLA FLESSIONE - BREAKING MODULUS - RESISTANCE A LA FLEXION - BIEGEFESTIGKEIT - RESISTENCIA A LA FLEXIÓN - ПРОЧНОСТЬ НА ИЗГИБ	ISO 10545-4	35 N/mm ² = 356 Kg/cm ²	SPESSORE 10 mm SPESSORE 11 mm SPESSORE 12 mm SPESSORE 20 mm	> 35 N/mm ²	
	SFORZO DI ROTTURA - MODULUS OF RUPTURE - CHARGE DE RUPTURE - BRUCHLAST - ESFUERZO DE ROTURA - СТОЙКОСТЬ НА ИЗГИБ		SPESSORE - THICKNESS - EPAISSEUR - STÄRKE - ESPESOR - ТОЛЩИНА ≥ 7,5 mm: min. 1300 N < 7,5 mm: min. 700 N	SPESSORE 4 mm SPESSORE 10 mm SPESSORE 11 mm SPESSORE 12 mm SPESSORE 20 mm	> 700 N > 1300 N 16060 N	
	DETERMINAZIONE DELLA RESISTENZA A FLESSIONE E CARICO DI ROTTURA - DETERMINATION OF BREAKING MODULUS AND MODULUS OF RUPTURE - DÉTERMINATION DE LA RESISTANCE À LA FLEXION ET À LA CHARGE DE RUPTURE - BESTIMMUNG DER BIEGEFESTIGKEIT UND DER BRUCHLASTBESTÄNDIGKEIT - DETERMINACIÓN DE LA RESISTENCIA A FLEXIÓN Y CARGA DE ROTURA - ОПРЕДЕЛЕНИЕ ПРОЧНОСТИ НА ИЗГИБ И РАЗРУШАЮЩЕЙ НАГРУЗКИ	UNI EN 1339:2005 / COR. 2011 ANNEX F	SPESSORE - THICKNESS - EPAISSEUR - STÄRKE - ESPESOR - ТОЛЩИНА 20 mm	SPESSORE 20 mm	CLASSE U11	
	RESISTENZA ALLA ABRASIONE DELLA SUPERFICIE DI PIASTRELLE SMALTATE RESISTANCE TO SURFACE ABRASION OF GLAZED TILES - RESISTANCE À L'ABRASION DE LA SURFACE DES CARREAUX ÉMALLÉS - WIDERSTAND GEGEN ABRASION DER OBERFLÄCHE DER GLASIERTEN FLIESEN - RESISTENCIA A LA ABRASION DE LA SUPERFICIE DE BALDOSAS ESMALTADAS - ПОВЕРХНОСТНОМУ ИСТИРАНИЮ ИСТИРАНИЮ	ISO 10545-7	-	-		
	RESISTENZA ALL'ABRASIONE PROFONDA DEEP ABRASION RESISTANCE - RESISTANCE A L'ABRASION PROFONDE - BESTÄNDIGKEIT GEGEN TIEFENVERSCHLEIB - RESISTENCIA A LA ABRASIÓN PROFUNDA - УСТОЙЧИВОСТЬ К ГЛУБОКОМУ СТИРАНИЮ ПО	ISO 10545-6	≤ 175 mm ³	117 mm ³		
	COEFFICIENTE DI DILATAZIONE TERMICA LINEARE - THERMAL EXPANSION COEFFICIENT - COEFFICIENT DE DILATATION THERMIQUE LINEAIRE - WÄRMEAUSENDENUNGSKOEFFIZIENT - COEFFICIENTE DE DILATACIÓN TÉRMICA LINEAL - ЗКОЭФФИЦИЕНТ ТЕПЛООВОГО ЛИНЕЙНОГО РАСШИРЕНИЯ	ISO 10545-8	METODO DISPONIBILE - AVAILABLE ON REQUEST - METHODE DISPONIBLE VERFÜGBARES VERFAHREN - METODO DISPONIBILE - ОПРЕДЕЛЯЕТСЯ ПРОИЗВОДИТЕЛЕМ	≤ 7x10 ⁻⁶ °C ⁻¹		
	RESISTENZA AL CAVILLO - CRAZING RESISTANCE - RESISTANCE AUX TRÉSAILLURES - HAARRISSE - RESISTENCIA AL QUARTEADO - СТОЙКОСТЬ К ОБРАЗОВАНИЮ РАЯТЕН	ISO 10545-11	-	-		
	RESISTENZA AGLI SBALZI TERMICI - THERMAL SHOCK RESISTANCE - RESISTANCE AUX ECARTS DE TEMPERATURE - TEMPERATURWECHSELBESTÄNDIGKEIT - RESISTENCIA A CHOQUE TÉRMICO - УСТОЙЧИВОСТЬ К ТЕМПЕРАТУРНЫМ ПЕРЕПАДАМ	ISO 10545-9	METODO DISPONIBILE - AVAILABLE ON REQUEST - METHODE DISPONIBLE VERFÜGBARES VERFAHREN - METODO DISPONIBILE - ОПРЕДЕЛЯЕТСЯ ПРОИЗВОДИТЕЛЕМ	RESISTENTI RESISTANT - RESISTANTS - WIDERSTANDSAFÄHIG - RESISTE - УСТОЙЧИВЫ		
	RESISTENZA AL GELO - FROST RESISTANCE - RESISTANCE AU GEL - FROSTBESTÄNDIGKEIT - RESISTENCIA AL HIELO - МОРОЗОСТОЙКОСТЬ	ISO 10545-12	RICHIESTA ALWAYS TESTED - EXIGÉE - NOTWENDIG - PEDIDO - ТРЕБОВАНИЯ	NON GELIVI FROST PROOF - NON GELIFS - FROSTSICHER - NO EXIGIDO - НЕ ЗАМОРАЖИВАЮТСЯ		
	RESISTENZA AI PRODOTTI CHIMICI - CHEMICAL RESISTANCE - RESISTANCE AUX PRODUITS CHIMIQUES - CHEMISCHE BESTÄNDIGKEIT - RESISTENCIA A LOS PRODUCTOS QUIMICOS - ХИМИЧЕСКАЯ УСТОЙЧИВОСТЬ	ISO 10545-13	min. UB min. GB	min. UB min. GB		
	PRODOTTI CHIMICI AD USO DOMESTICO ED ADDITIVI PER PISCINA - HOUSEHOLD CHEMICALS AND SWIMMING POOL WATER CLEANSERS - PRODUITS CHIMIQUES COURANTS ET ADDITIFS POUR PISCINE - CHEM. PRODUKTE FÜR DEN HAUSHALTSGEBRAUCH UND ZUSATZ FÜR SCHWIMMBÄDER - PRODUCTOS QUIMICOS PARA USO DOMÉSTICO Y CON ADITIVOS PARA PISCINA - БЫТОВЫЕ ХИМИЧЕСКИЕ СРЕДСТВА И СРЕДСТВА ДЛЯ БАССЕЙНОВ		DA GLA, GLB A ULC FROM GLA, GLB TO ULC DE GLA, GLB A ULC VON GLA, GLB BIS ULC DE GLA, GLB A ULC OT GLA, GLB DO ULC	DA GLA, GLB A ULC FROM GLA, GLB TO ULC DE GLA, GLB A ULC VON GLA, GLB BIS ULC DE GLA, GLB A ULC OT GLA, GLB DO ULC		
	ACIDI ED ALCALI A BASSA CONCENTRAZIONE - ACIDS AND LOW CONCENTRATION ALKALIS - ACIDES ET ALCALI A FAIBLE CONCENTRATION - SÄUREN UND ALKALI IN GERINGER KONZENTRATION - ÁCIDOS Y ÁLCALIS EN BAJA CONCENTRACIÓN - НИЗКОКОНЦЕНТРИРОВАННЫЕ КИСЛОТЫ И ЩЕЛОЧИ		METODO DISPONIBILE - AVAILABLE ON REQUEST - METHODE DISPONIBLE VERFÜGBARES VERFAHREN - METODO DISPONIBILE - ОПРЕДЕЛЯЕТСЯ ПРОИЗВОДИТЕЛЕМ	METODO DISPONIBILE - AVAILABLE ON REQUEST - METHODE DISPONIBLE VERFÜGBARES VERFAHREN - METODO DISPONIBILE - ОПРЕДЕЛЯЕТСЯ ПРОИЗВОДИТЕЛЕМ		
	ACIDI ED ALCALI AD ALTA CONCENTRAZIONE - ACIDS AND HIGH CONCENTRATION ALKALIS - ACIDES ET ALCALI A FORTE CONCENTRATION - SÄUREN UND ALKALI IN HOHER KONZENTRATION - ÁCIDOS Y ÁLCALIS EN ALTA CONCENTRACIÓN - ВЫСОКОКОНЦЕНТРИРОВАННЫЕ КИСЛОТЫ И ЩЕЛОЧИ	ISO 10545-14	METODO DISPONIBILE - AVAILABLE ON REQUEST - METHODE DISPONIBLE VERFÜGBARES VERFAHREN - METODO DISPONIBILE - ОПРЕДЕЛЯЕТСЯ ПРОИЗВОДИТЕЛЕМ	min. 4		
	RESISTENZA ALLE MACCHIE - STAIN RESISTANCE - RESISTANCE AUX TACHES - FLECKBESTÄNDIGKEIT - RESISTENCIA A LAS MANCHAS - УСТОЙЧИВОСТЬ К ЗАГРЯЗНЕНИЮ	ISO 10545-14	METODO DISPONIBILE - AVAILABLE ON REQUEST - METHODE DISPONIBLE VERFÜGBARES VERFAHREN - METODO DISPONIBILE - ОПРЕДЕЛЯЕТСЯ ПРОИЗВОДИТЕЛЕМ	min. 4		
	STABILITÀ DEI COLORI ALLA LUCE - COLOUR STABILITY TO LIGHT - STABILITÉ DES COULEURS A LA LUMIERE - LICHTECHTHEIT DER FARBEN - ESTABILIDAD DE LOS COLORES - УСТОЙЧИВОСТЬ ЦВЕТА	DIN 51094	NON DEVONO PRESENTARE APPREZZABILI VARIAZIONI DI COLORE THEY DO NOT HAVE TO SHOW VISIBLE COLOUR ALTERATION PAS DE MODIFICATIONS SENSIBLES DE COULEUR WEISEN KEINE SICHTBAREN FARBARWEICUNGEN AUF NO DEBEN PRESENTAR VARIACIONES DE COLOR APRECIABLES НЕ ДОЛЖНЫМЕТЬ ЗАМЕТНЫХ РАЗЛИЧИЙ ЦВЕТА	CONFORME COMPLIANT CONFORME ERFÜLLT CUMPLE СООТВЕТСТВУЕТ		
	COEFFICIENTE DI ATTRITO (SCIVOLOSITÀ) - FRICTION COEFFICIENT (SLIPPERINESS)	ANSI A 137.1:2012	≥ 0,42	≥ 0,42 SUPERFICIE NATURALE NATURAL SURFACE		

Tra i fondi di spessore 10 e 20 mm (40x120 - 40x80) non si garantisce l'abbinabilità. - We cannot guarantee tonal matches between the same background tiles with different thickness (10 or 20 mm : 40x120 - 40x80). - Les assortiments des tons ne sont pas garantis pour les fonds d'une épaisseur de 10 et 20 mm (40x120 - 40x80). Bei Bodenfliesen mit einer Stärke von 10 und 20 mm (40x120 - 40x80) wird keine Einheitlichkeit der Farbtöne garantiert. - Para los fondos de espesor 10 y 20 mm (40x120 - 40x80) no se garantiza la combinabilidad de tonalidades. - Для фоновой плитки толщиной 10 и 20 мм (40x120 - 40x80) не гарантирована цветовая сочетаемость.

LA FABBRICA S.p.A. si riserva di apportare, senza alcun preavviso, le modifiche che riterrà più opportune al fine di migliorare il prodotto. Quanto riportato è da considerarsi indicativo e non esaustivo in riferimento ai colori e alle caratteristiche estetiche dei prodotti.
LA FABBRICA S.p.A. reserves the right to make any changes it deems fit in order to improve the product, without prior notice. All images are provided for illustrative purposes only and other colours and aesthetic features are available.



Civilization of Beauty

La Fabbrica S.p.A. - Via Emilia Ponente, 925
48014 Castel Bolognese (RA) Italy
Tel. +39 0546 - 659911 - Fax +39 0546 - 656223
www.lafabbrica.it - info@lafabbrica.it

DAFIN GROUP



www.avaceramica.it



Civilization of Beauty

www.lafabbrica.it



www.iblspa.it